

MINIPUMP MP-W5P

OPERATION MANUAL

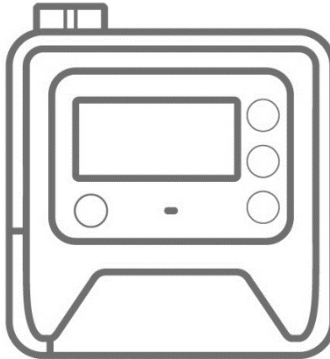

Thank you for purchasing this product.

- This operation manual describes precautions that are important for preventing accidents as well as procedures used to handle the product.
- Read this operation manual and the attached warranty thoroughly before use, and use the product correctly.
- After reading this operation manual and the warranty, keep them handy for future reference.

Contents

1 Introduction	4
1.1 Notations in this manual	4
1.1.1 DANGER, WARNING, CAUTION	4
1.1.2 IMPORTANT, NOTE	4
1.1.3 Symbols.....	4
1.2 Checking the packed items.....	5
1.3 Definitions of target users for this product	5
2 Safety Precautions	6
3 About This Product.....	10
3.1 Overview.....	10
3.2 Features	10
3.3 Part Names.....	11
4 How to Use This Product	13
4.1 Removing and mounting the battery	13
4.1.1 Removing the battery	13
4.1.2 Mounting the battery.....	14
4.2 Wiring	16
4.2.1 Using this product with an AC power supply.....	16
4.2.2 Using this product with the battery	16
4.3 Charging.....	17
4.4 Installation and Piping	17
4.4.1 About intake pressure.....	18
4.4.2 When using an impinger.....	18
4.5 Removing and mounting the intake holder	19
4.6 Using color caps.....	20
4.7 Preparations for operation	21
4.8 Operation mode.....	22
4.8.1 Before sampling	22
4.8.2 Flow rate setting	23
4.8.3 Sampling start time setting	23
4.8.4 Sampling end condition setting.....	23
4.8.5 Down timer setting.....	24
4.8.6 Volume timer setting.....	24
4.8.7 Sampling standby.....	25
4.8.8 During sampling	26
4.8.9 Pause Function	27
4.8.10 After end of sampling.....	29

4.9 Error	30
4.10 Numeric value overrun	31
4.10.1 Accumulated flow volume	31
4.10.2 Sampling time.....	31
4.10.3 Instantaneous flow rate	31
4.11 Calibration.....	32
4.12 Memory.....	34
4.13 Extra menu	36
4.13.1 Clock	36
4.13.2 Flow rate conversion temperature	37
4.13.3 Backlight ON setting.....	37
4.13.4 Operation display LED ON setting.....	38
4.13.5 Data deletion	38
4.13.6 Power ON time	39
4.13.7 Motor operation time	39
4.13.8 Flow Rate Error Threshold Setting	39
5 Troubleshooting.....	40
6 Maintenance	41
6.1 Replacing the filter element	41
6.2 About periodic inspection.....	41
7 Specifications.....	42
7.1 Specifications	42
7.2 Accessories and Products Sold Separately	43
7.3 Options and consumable parts	43
7.4 About operating sound.....	43
8 LCD Screen List	44
9 Warranty and Repair.....	45
10 Disposal of the Product	46
11 Inquiries	46
12 Problem Notification Sheet.....	47

1 Introduction



1.1 Notations in this manual

1.1.1 DANGER, WARNING, CAUTION

This product is designed with ultimate priority on the safety of operators. However, due to the nature of this product, there are risks that cannot be removed.

In this manual, the level of significance and risk is defined and indicated in three stages, “DANGER”, “WARNING”, and “CAUTION”. Thoroughly read and fully understand the indicated items before operating this product and performing maintenance procedures.

The indication for “DANGER”, “WARNING”, and “CAUTION” is described below in order of risk significance (DANGER > WARNING > CAUTION).

 DANGER	“DANGER” indicates an imminently hazardous situation that, if not avoided, will result in death or serious injury.
 WARNING	“WARNING” indicates a potentially hazardous situation that, if not avoided, will result in death or serious injury.
 CAUTION	“CAUTION” indicates a potentially hazardous situation that, if not avoided, may result in minor or moderate injury, or damage to items.



1.1.2 IMPORTANT, NOTE

In addition to DANGER, WARNING, and CAUTION described above, important or necessary items for users are indicated as follows.

IMPORTANT	Indicates important information that must be noted as operational requirements.
	Indicates important information that is helpful to remember as operational requirements.

1.1.3 Symbols

This Operation Manual uses the following symbols that simply describe warning information in addition to the indications, “DANGER”, “WARNING”, “CAUTION”, and “IMPORTANT”,

	Indicates a danger that may inflict bodily injury.
	Indicates a PROHIBITED action that must not be performed.
	Indicates a REQUIRED action that must be performed.

1.2 Checking the packed items

The items shown below are packed with this product.
 After unpacking, check that you have received the items shown above.
 If any item is missing or damaged, contact your Sibata agent.

■ Mini pump MP-W5P with NI-W5 (Item Code 090860-50601)



- MP-W5P main body 1 unit
- Color cap red, blue, yellow 1 pc. each
- NI-W5 Nickel metal-hydride battery 1 pc.

■ Mini pump MP-W5P with NI-W5 QCA-W5 Color cap (Item Code 090860-50602)

- MP-W5P main body 1 unit
- Color cap red, blue, yellow 1 pc. each
- NI-W5 Nickel metal-hydride battery 1 pc.
- QCA-W5SE Quick charger 1 pc.
- UES18LCP AC adapter 1 pc.

■ Mini pump MP-W5P with SN3-6B (Item Code 090860-50603)

- MP-W5P main body 1 unit
- Color cap red, blue, yellow 1 pc. each
- SN3-6B Battery holder 1 pc.

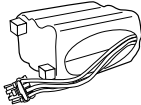
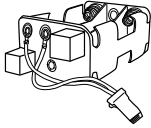
			
MP-W5P Mini pump main body	Color cap Red, blue, yellow	NI-W5 Nickel metal-hydride battery	SN3-6B Battery holder

1.3 Definitions of target users for this product

This product must be operated only by persons with adequate specialist skills, training, and experience to understand the potential dangers of operating the product.





Personnel who are untrained or still undergoing training may operate the product only under guidance from a trained person or a person with specialized experience.

This Operation Manual was written on the assumption that the product will be operated only by users who fully understand the potential dangers of operating the product.







2 Safety Precautions

The warning labels and indications stated in this Operation Manual are intended to ensure operation of the product in a safe and correct manner and prevent hazards to you or other personnel or damage to property. Since the warning labels and indications include important safety instructions, read them carefully to fully understand their contents before starting operation, and always strictly observe them.

DANGER

-  Do not use any batteries other than the dedicated batteries (NI-W5 nickel metal-hydride battery or AA dry cells) for the pump body of this product. Doing so might cause a failure or personal injury.
-  Be sure to use the dedicated QCA-W5/QCA-W5SE quick charger when charging this product. Charging the product in other ways may cause leakage of battery liquid leakage, generation of heat, or explosion.
-  Do not allow the product to intake gases other than atmospheric air in a place close to strongly combustible or flammable materials. Doing so might cause explosion or fire.
-  No Fires Allowed. Do not put this product into a fire. Doing so might cause explosion or fire.

WARNING

-  Do not connect the connector of the nickel metal-hydride battery with metals, such as wires. Doing so might cause burns, battery leakage, generation of heat, or explosion.
-  Do not allow this product to be directly splashed with water. Doing so might cause electric shock or fire.
-  Never disassemble or modify this product. Doing so may cause a failure or accidents.
-  Do not run this product wrapped in a cloth or bedding, or enclosed in a box. Doing so may cause heat to build up, resulting in fire or a failure.
-  Do not connect the power adapter to a multi-plug power strip. Doing so may cause electric shock or fire. Before using this product on a non-specified voltage, contact your Sibata agent.
-  Do not use this product when the power cable is damaged or the plug inlet on the power outlet is loose. Using this product in this state may cause fire or electric shock.
-  Do not touch the power cable or power outlet with wet hands. Doing so may cause electric shock.

 **WARNING**



Do not block the exhaust port. Otherwise, the required flow rate cannot be obtained or the internal temperature may increase, causing a failure or fire.



Do not allow this product to intake in flammable gas. Doing so might cause a failure or fire. Additionally, do not allow this product to intake salt air, corrosive gas, or chemicals. Doing so might cause a failure.



If an abnormality occurs during operation, immediately stop operation and remove the cause of the abnormality. If you determine that the abnormality is caused by this product, remove the battery and contact your Sibata agent. Do not use this product in an abnormal state or allow a person other than the service personnel to disassemble it. Doing so may cause a failure or accidents.

 **CAUTION**



Do not subject this product to strong impact or drop it. Doing so may cause a failure or accidents.



Do not install or store this product inside a vehicle in extreme temperatures, in a place exposed to the strong direct sunlight, in front of a heater, or near a fire. Doing so might cause abnormal operation or a failure.



Never connect the connectors in a way other than that instructed and specified in this manual, such as connection with wires or other metals. Doing so might cause fire or the product to break.



This product is designed for indoor use. Do not use it in environments that may be exposed to wind and rain. Doing so may cause a failure.



Do not wash this product with water. Doing so might cause electric shock, fire or a failure.



This product is exclusively for sampling air. Do not use it for purposes other than those described in this manual. Doing so may cause a failure.



Do not allow this product to intake liquids such as water or gases other than the atmospheric air. Doing so might cause a failure.



Do not insert screws or other foreign objects into the intake and exhaust ports. Doing so may cause a failure. If a foreign object enters this product, immediately turn the power switch OFF, disconnect the power plug, and contact your Sibata agent.



Do not place heavy objects or step on the power cable. Doing so might cause electric shock or fire.

 **CAUTION**



Install this product on a horizontal, stable, horizontal surface. Doing so might cause abnormal operation or a failure.



The NI-W5 nickel metal-hydride battery has a fixed service life (about 300 charge and discharge cycles in normal operation). When the operation time of the product starts to shorten, replace the NI-W5 with a new one. If used after the replacement period has passed, the battery may fail, causing the battery liquid to leak.



When the product is not used for an extended period of time, disconnect the battery and power adapter, and then store it in a cool and dry place not exposed to the direct sunlight.



Do not place objects on top of this product. Doing so might cause fall-down, deformation, accident, or failure.



When performing the assembly work, such as mounting of the battery, be careful not to pinch your fingers.



Be sure to operate this product with a filter element attached to the intake holder. In addition, operate this product with the dust collector attached to the intake port. Using this product to intake atmospheric air for an extended period of time may cause a failure.



Be sure to hold the plug when disconnecting the power cable. Pulling the cable may damage it, causing electric shock or fire.



The operating temperature and humidity ranges of this product are 0 to 40°C and 10 to 90%RH (no condensation). Using this product outside these ranges might impair its performance and shorten the service life, and thus might result in a failure.



Before using this product, check the sheath of the power adapter cable for any scratches or other abnormality. Using this product in an abnormal state may cause fire or electric shock.



Before cleaning or inspecting this product, remove the battery and the power adapter. Failure to do so may cause electric shock, electric leakage, or other abnormalities.



Do not put any device that generates noise close to this product. Additionally, do not install this product in a place with a strong magnetic field, large volume of fine particles, or high humidity. Doing so might cause the product to fail.

IMPORTANT	<p>Even when the NI-W5 nickel metal-hydride battery is not used for an extended period of time, recharge it at least once every six months to prevent over-discharge of the battery. This may prevent deterioration of the NI-W5.</p>
	<p>Note that even if a failure occurs, Sibata shall not be held responsible for any compensation for the contents of any data that was not acquired or recorded, any lost data, and other direct, indirect, or consequential damages resulting from this failure. Be sure to back up the data periodically to prepare as a safeguard against possible failure or accident.</p>
	<p>Avoid sampling asbestos using this product. Asbestos has recently become a high-profile social issue. The asbestos measurement methods include <u>collection of samples at 5 L/min. for 2 hours</u> (as per the JATI guidelines for indoor air). Due to the special characteristics of the filter used for this measurement method, a significant load is applied to the pump. As a result, a pump with sufficient intake pressure (10 kPa or more) needs to be used. The intake flow rate range of this product is 0.05 to 5 L/min. However, <u>the intake pressure will be 0 to 3.0 kPa during intake at 5 L/min. This means that the specification range is exceeded when this product is used to collect samples at 5 L/min. for 2 hours.</u></p> <p>If the product is used under these conditions, it cannot perform the intake, becomes more susceptible to failure, and does not operate correctly. To perform the measurements under these conditions, use the AIP-105 or AIP-205 Asbestos Sampling Pump. Note that even if a problem occurs when this product is used under these conditions, it is not covered by the one-year warranty.</p>
	<p>When transferring products previously used in your country or third countries to the EU market, check that they are not contaminated by regulated substances. Please understand Sibata shall not be held responsible for any problems that may occur once the product is used.</p>

3 About This Product

3.1 Overview

This MP-W5P mini pump is a compact, lightweight, and portable air mini pump that incorporates an accumulated flow volume measurement function. The pump can be used in a wide flow rate range of 0.05 to 5.0 L/min. The pump incorporates a constant flow rate function to minimize drops in intake flow rate accompanying increases in intake pressure caused by sampling of dust particles.

As the flow rate range is wide and stable, this pump can be used in a wide variety of applications as a pump for sampling airborne harmful substances in work, indoor and atmospheric air environments.



3.2 Features

- The pump is equipped with a pause function.
- The flow rate range is wide, 0.05 to 5.0 L/min.
- The dimensions are 95 (W) × 56 (D) × 95 (H) mm, a compact size convenient for carrying.
(The smallest size in Sibata's pump models with a intake flow rate of 3 L/min. or more.)
- The pump incorporates a constant flow rate function to minimize drops in intake flow rate accompanying increases in intake pressure caused by sampling of dust particles.
- Contains three timer sampling modes (manual, down timer, volume timer).
- The liquid crystal display incorporates a backlighting function. The displayed flow rate and other values can be checked even in dark locations.
- Compatible with three kinds of power supplies
 - NI-W5 nickel metal-hydride battery
 - Six AA dry cells (SN3-6B battery holder)
 - QCA-W5 quick charger or QCA-W5SE quick charger and UES18LCP AC adapter

Use of this quick charger makes it possible to operate the pump with an AC power supply.

The quick charger is applicable to an AC power supply ranging from 100 to 240 V. (For details, see the Operation Manual for the quick charger or the AC adapter.)

3.3 Part Names

Pump Body

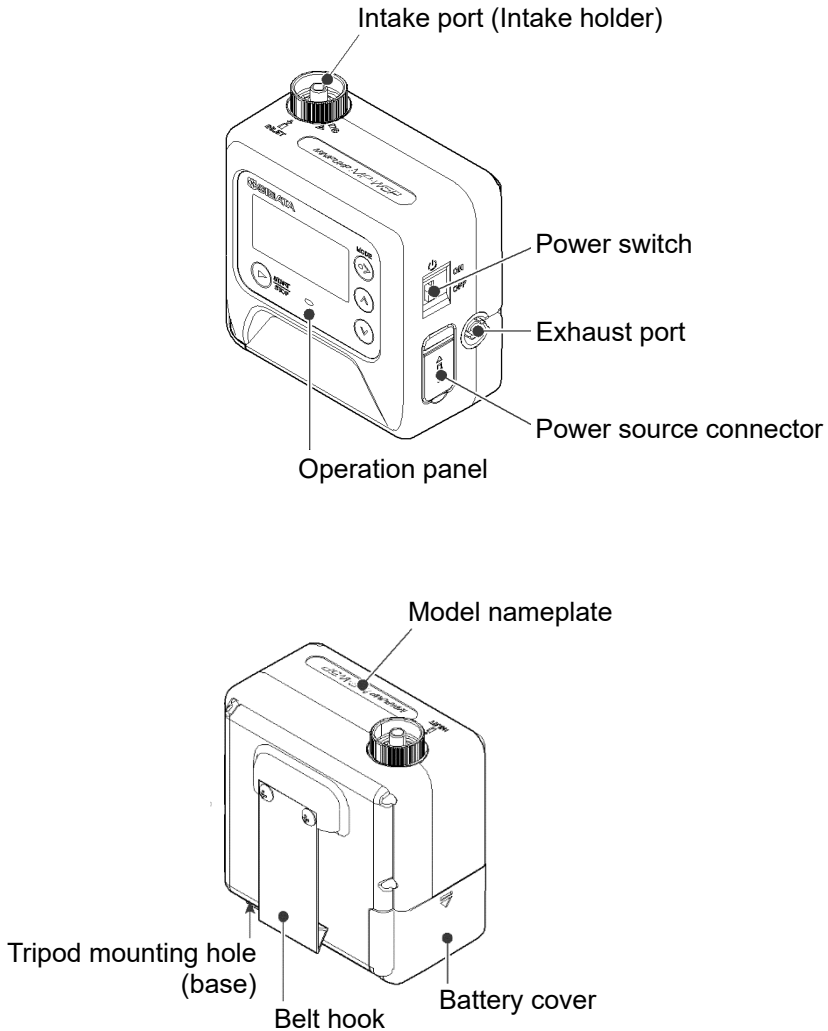

Operation panel



LCD Screen

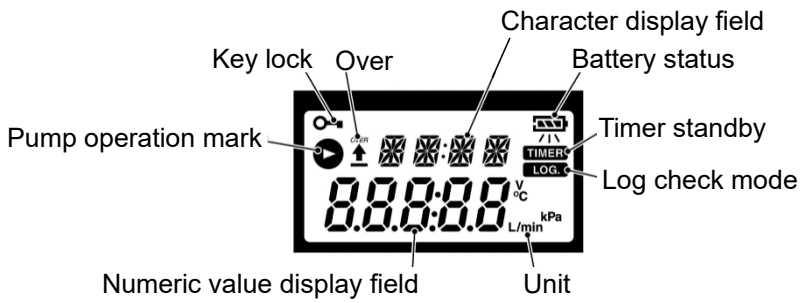

4 How to Use This Product

4.1 Removing and mounting the battery

⚠ CAUTION



Be sure to turn OFF the power to the pump body before removing or mounting the battery. Failure to follow this instruction might cause a failure or electric shock.

4.1.1 Removing the battery

- 1 Remove the battery cover from the left side of the pump body.

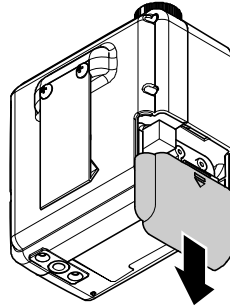

- 2 Disconnect the connector that connects the battery holder or nickel metal-hydride battery while pressing the arrow mark portion shown in the figure on the right.

Note: Be careful not to pull the cable.

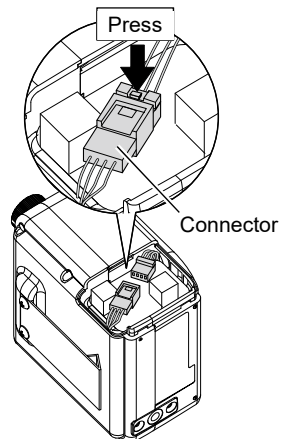

-
- 3** Carefully remove the battery holder or nickel metal-hydride battery so that the cable is not caught.

Note: Be careful not to pull the cable.

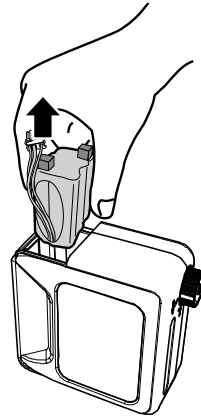

-
- 4** Replace the dry cells with new ones or replace the nickel metal-hydride battery with a one supplied with the product or a new one.
-



No dry cells are contained in the pump body when you unpack the product. So prepare dry cells separately. (Rechargeable dry cells with the same shape are also usable.)

When you want to use the nickel metal-hydride battery, replace the battery holder with the nickel metal-hydride battery.

4.1.2 Mounting the battery

- 1** Carefully mount the battery holder or nickel metal-hydride battery so that the cable is not caught.

Note: Pay special attention to the cable orientation.

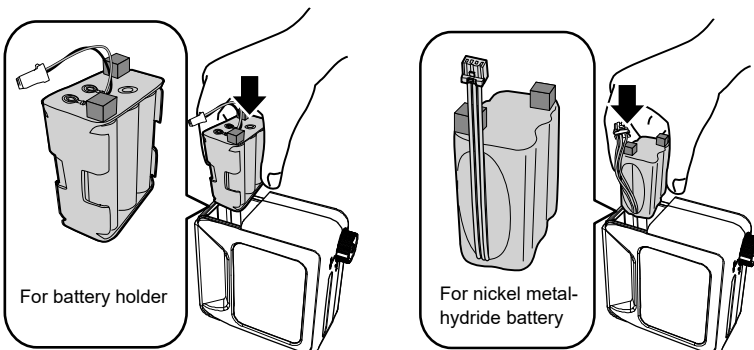

-
- 2** Connect the connector.

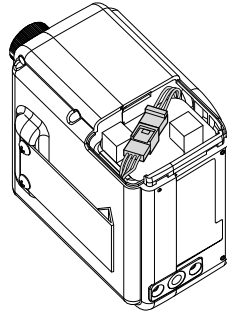

-
- 3** Carefully mount the battery cover so that the cable is not caught.

Note: Press the cover while sliding it to fit into place.

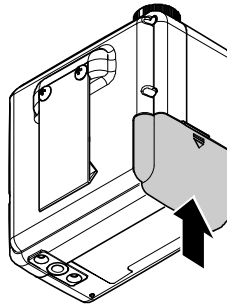

■ About disposal of rechargeable battery in Japan

The nickel metal-hydride battery is recyclable. Attach an appropriate insulating tape, such as Scotch tape, to the terminal and metal portions of an unneeded nickel metal-hydride battery, and take it to a shop cooperating with recycling.



Ni-MH

■ About disposal of rechargeable battery in countries outside Japan

Dispose of an unneeded rechargeable battery according to the laws and regulations of each country.

4.2 Wiring

4.2.1 Using this product with an AC power supply

The pump body can be operated with an AC power supply by connecting the QCA-W5/QCA-W5SE* quick charger to the pump body. Additionally, when the NI-W5 nickel metal-hydride battery is mounted in the pump body, the NI-W5 nickel metal-hydride battery can be charged at the same time as the pump body operates.

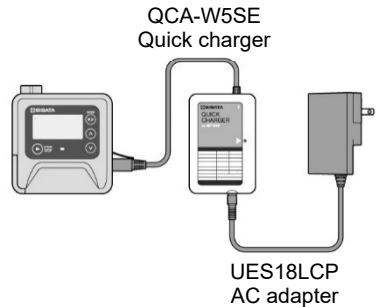

* The UES18LCP AC adapter, which is separately available, is necessary for the QCA-W5SE.

IMPORTANT	<p>The QCA-W5 quick charger can be used in an AC power supply range of 100 to 240 V. However, the shape of the plug supplied with the QCA-W5 quick charger is dedicated for 100 V. When using the quick charger at another voltage, use a power cable that complies with the regulations in the relevant country. The UES18LCP AC adapter (for the QCA-W5SE quick charger) supports power supplies in countries other than Japan and comes with four types of adapter plugs. Attach an adapter plug suitable for the specifications in the applicable country before use. For details, see the Operation Manual for the quick charger or AC adapter.</p>
------------------	--

4.2.2 Using this product with the battery

When turning ON the power with the nickel metal-hydride battery or dry cells mounted, the battery status icon is displayed on the screen. (This icon is not displayed when the product is connected to the AC power supply.)

Battery status



70% or more



30% or more



Less than 30%



0% The pump stops operating. The battery must be recharged or replaced immediately.

IMPORTANT	<p>When using dry cells other than alkaline dry cells, the battery status icon does not function correctly.</p>
	<p>Do not remove the battery during pump operation.</p>

	<p>When operating the product with an AC power supply after the nickel metal-hydride battery or dry cells have been mounted, the power supply is changed to the nickel metal-hydride battery or dry cells automatically to continue the measurement even if a power failure occurs. When using the nickel metal-hydride battery, it is charged automatically after the AC power supply has been recovered. This ensures safer measurement.</p>
--	--

4.3 Charging

Charge the battery with the QCA-W5/QCA-W5SE * quick charge.

Connect the quick charger to the pump body as shown in the figure below to charge the battery.

When the LED on the quick charger blinks in red, this shows that the battery is charging. When the LED turns lit in green, the charging is complete.

The charging time is about six hours.

For details, see the Operation Manual for QCA-W5/QCA-W5SE quick charger.

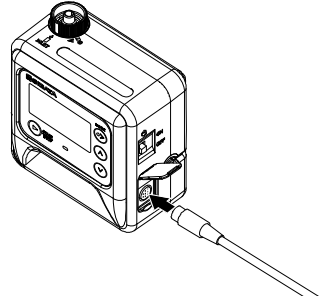

* The UES18LCP AC adapter, which is separately available, is necessary for the QCA-W5SE.

CAUTION



Be sure to use the QCA-W5/QCA-W5SE quick charger to charge the battery. Using another device may cause a failure or abnormal overheating, which results in fire or explosion.

4.4 Installation and Piping

Install the pump body in a flat place. At this time, avoid humid places, wet places, places near fire or heat sources, and places with large volumes of fine particles.

The pump body can also be mounted on a tripod. Insert the tripod screws into the tripod mounting holes on the base of the pump body. Be aware that the pump body cannot be installed steadily when using a tripod whose platform is more than 40 mm long (a width of 20 mm or more around the tripod screws).

Make sure that the filter element is attached to the intake holder. Additionally, if the filter element is extremely contaminated, replace it with a new one. (See page 19.)

A tube with an inside diameter of 5 mm or 7 mm can be connected to the intake port.

IMPORTANT

Take great care so that strong force is not applied to the intake holder during piping work. When connecting the piping forcibly, this may cause breakage.

An exhaust port is provided on the pump body, but it is not recommended to connect the piping, such as a tube to the exhaust side.

If a load exceeding 3 kPa is applied to the exhaust side, the pump may malfunction.

The piping can be connected to the exhaust port only when this product is connected in the middle of the piping to return the sampled air to its original place. In this case, use a tube with an inside diameter of 7 mm.

4.4.1 About intake pressure

A load (intake pressure) is applied to this product by collected matter in the collector installed on the intake port. With this product, the maximum intake pressure at each flow rate is fixed (See page 42). If the intake pressure exceeds its specified range, this may cause a failure. However, no intake pressure measurement function is provided on this product. So, it is recommended to measure the intake pressure of the collected matter beforehand while referring to the diagram.

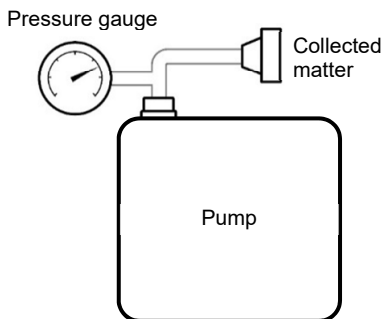

4.4.2 When using an impinger

If the piping is incorrectly connected to the mini pump using an impinger, liquid enters the pump body, causing a failure. Connect the piping while referring to the figure below.

Note that an impinger holder cannot be installed on this product. So, install the pump body and impinger separately.

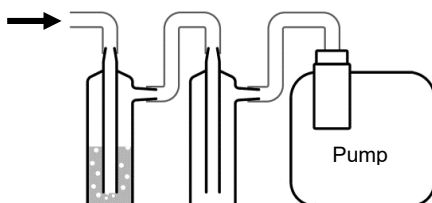

Install piping on the pump as shown in the figure above to prevent the liquid from being pumped in directly. We also recommend that you set up a multi-stage trap on the pump intake side.

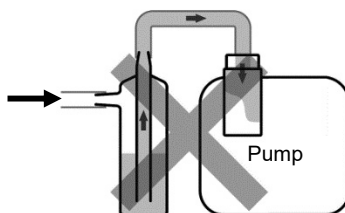

Never install piping in such a way that the liquid is pumped in directly as shown in the figure above.

4.5 Removing and mounting the intake holder

- 1** Turn the intake holder that is mounted on the intake port counterclockwise.

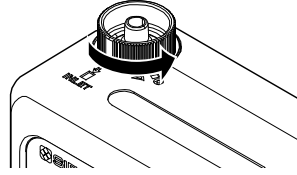

- 2** Lightly pull the filter element to remove it from the intake holder, and then replace it with a new one.

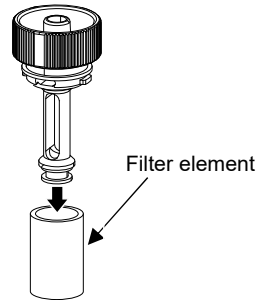

- 3** Put the intake holder and filter element in the pump body.

Note: Be sure to attach the filter element to the intake holder.

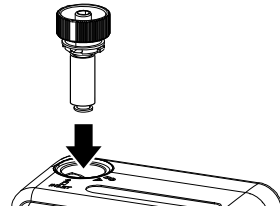

- 4** Align the positioning mark on the intake holder with the ◯ mark on the pump body.

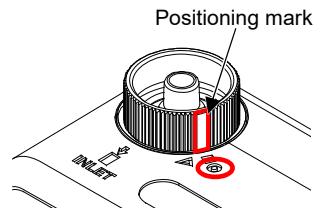

- 5** Turn the intake holder clockwise to "INLET" while pressing the intake holder to lock it securely.

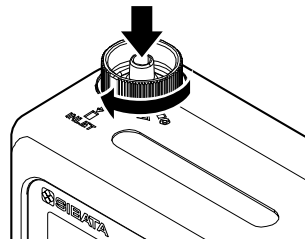

4.6 Using color caps

The color caps supplied with this product are used to identify a specific pump when using multiple pumps. A color cap can be mounted on the screw thread portion at the top of the intake holder.

IMPORTANT

The maximum outside diameter of a tube that can be connected to the color cap is 10 mm. Be aware that a tube with an outside diameter of more than 10 mm cannot be connected.

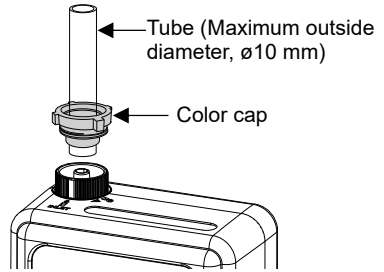

The color cap also functions as a tube stopper when using it with a tube with an inside diameter of 7 mm and an outside diameter of 10 mm that is connected to the intake holder. Use this mechanism when performing measurements in which the tube is disconnected easily, such as personal exposure measurements.

IMPORTANT

The color cap functions as a tube stopper, but this function is not guaranteed. Be sure to confirm that the tube is not disconnected before starting the measurement. Sibata shall not be held responsible for any defects arising from tube disconnection during measurement.



When mounting the color cap on the intake holder, it is not necessary to turn the screw strongly. If the screw is turned strongly, the screw may break and the color cap cannot be removed.

In particular, be aware that the screw is difficult to turn when using the color cap as a tube stopper. Sufficient tube stopper effect is obtained by turning the screw so that one screw thread remains.

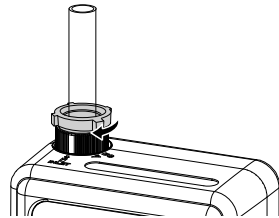

When removing the color cap, remove the color cap together with the intake holder, and then remove the color cap from the intake holder. After that, return the intake holder to the pump body.

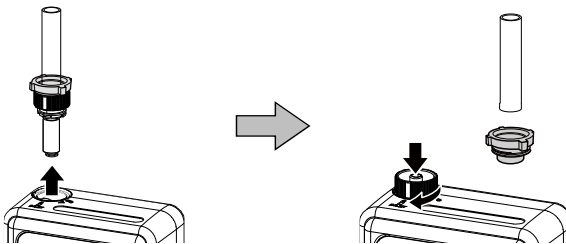

4.7 Preparations for operation

Make sure that the wiring and piping are connected securely.

Turn ON the power switch on the side of the pump body.

The screen shown in the figure below is displayed after the version and flow rate conversion temperature have appeared.

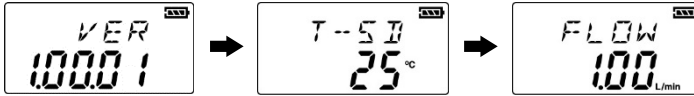

Note: When operating the pump with the AC power supply, the battery status mark is not displayed.

Each time you press the MODE key, the screen cyclically switches as follows: operation mode, calibration mode, memory, and then an extra menu.

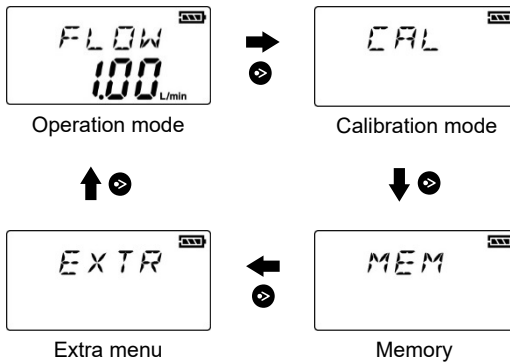

4.8 Operation mode

LCD notation  Blink  Lit

4.8.1 Before sampling

Press the MODE key until FLOW is displayed.
The flow rate setting is displayed on the initial screen.
The accumulated flow volume may also be displayed.
(See page 29.)



Each time you press the UP key, the screen cyclically switches as follows: flow rate setting, sampling start time, sampling time or sampling accumulated flow volume, last data (several pages), and then flow rate setting. Pressing the DOWN key switches the screen in the reverse direction.

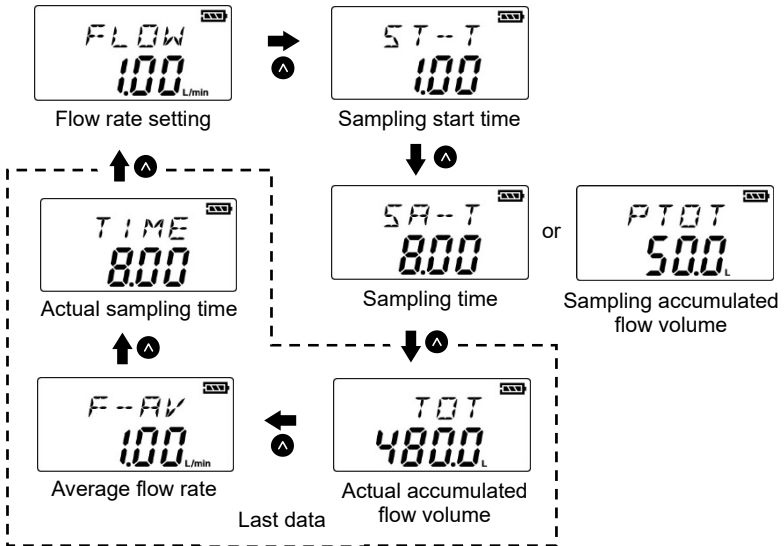

Select an operation mode from the three modes shown below, and set each value.

Operation mode	Values to be set	Description
Manual	Flow rate	Pressing the START/STOP key will start or stop the operation.
Down timer	Flow rate Sampling start time Sampling time	When you press the START/STOP key, the operation starts at the set time and stops after the set time (number of minutes) has elapsed.
Volume timer	Flow rate Sampling start time Sampling accumulated flow volume	When you press the START/STOP key, the operation starts at the set time and stops when the accumulated flow volume reaches the set level.

4.8.2 Flow rate setting

When you hold down the MODE key on the flow rate setting screen (FLOW is displayed), the flow rate value blinks. Then, you can set the flow rate.

Set the flow rate by changing the numeric value with the UP/DOWN key.

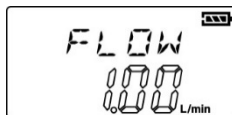

When you press the START/STOP key after setting the flow rate, the flow rate value lights up, and the setup is complete.

At this time, when you press the MODE key without pressing the START/STOP key, the screen moves to the sampling start time setting screen.

4.8.3 Sampling start time setting

Set a period of time (number of hours and number of minutes) in minutes so that the sampling starts after this period of time has elapsed once the START/STOP key is pressed. When setting "0.00", the sampling starts immediately (manual start).

When you hold down the MODE key on the sampling start time screen (ST-T is displayed), the hour value blinks. Then, you can set the sampling time (hour). Set the sampling start time (hour) by changing the numeric value with the UP/DOWN key.

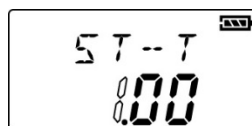

Sampling start time (hour)

When you press the MODE key, the minute value blinks, allowing you to set the sampling start time (minute). Set the sampling start time (minute) by changing the numeric value with the UP/DOWN key. Up to 999.59 (999 hours and 59 minutes) can be set for the sampling start time.



When you press the START/STOP key after setting the sampling start time, the hour and minute values light up, and the setup is complete.

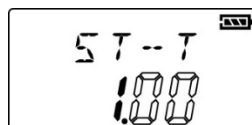

Sampling start time (minute)

At this time, when you press the MODE key without pressing the START/STOP key, the screen moves to the sampling end condition setting screen.

4.8.4 Sampling end condition setting

When you hold down the MODE key on the sampling end condition setting screen (SA-T or PTOT is displayed), SA-T or PTOT blinks. At this time, pressing the UP/DOWN key switches between SA-T and PTOT. SA-T shows the down timer while PTOT shows the volume timer. You can switch between the down timer and volume timer on this screen. When the MODE key is pressed, the sampling end condition is determined and you can proceed to the timer setting.

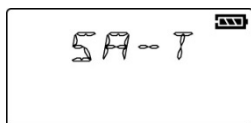

Down timer

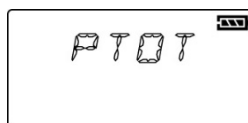

Volume timer

4.8.5 Down timer setting

When you press the MODE key while SA-T is blinking, the hour value blinks.

Then, you can set the sampling time (hour). Set the sampling time (hour) by changing the numeric value with the UP/DOWN key.



Sampling time (hour)



When you press the MODE key, the minute value blinks, allowing you to set the sampling time (minute). Set the sampling time (minute) by changing the numeric value with the UP/DOWN key.

Up to 999.59 (999 hours and 59 minutes) can be set for the sampling time.

When you press the START/STOP key after setting the down timer, the hour and minute values turn lit, and the setup is complete.

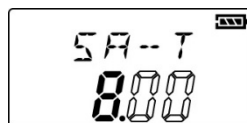

Sampling time (minute)

At this time, when pressing the MODE key without pressing the START/STOP key, the screen returns to the flow rate setting screen.

4.8.6 Volume timer setting

When you press the MODE key while PLOT is blinking, the accumulated flow volume blinks.

Then, you can set the volume timer.

Set the accumulated flow volume by changing the numeric value with the UP/DOWN key.



Volume timer setting

When a value exceeding 999.99 L is set for the accumulated flow volume, "1000.0 L" is displayed, allowing you to enter up to 9999.9 L.

When you press the START/STOP key after setting the accumulated flow volume, the value of the accumulated flow volume is lit, and the setup is complete.

At this time, when pressing the MODE key without pressing the START/STOP key, the screen returns to the flow rate setting screen.



When "0.00" is set for the down timer or volume timer, the operation starts in the manual mode (the operation does not stop unless the START/STOP key is pressed).

4.8.7 Sampling standby

When you press the START/STOP key on the operation mode screen, the operation display LED blinks in orange, the timer standby icon is displayed on the screen, and the remaining sampling start time is displayed.

Note: When “0.00” is set for the start time, pressing the START/STOP key will start the pump operation immediately.

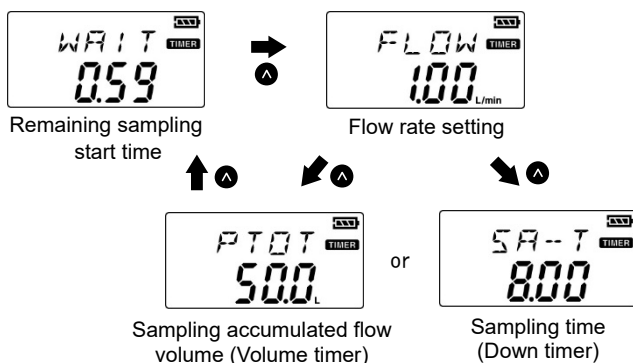

Pressing the UP key switches the screen cyclically: flow rate setting, sampling time or sampling accumulated flow volume, and remaining sampling start time. Pressing the DOWN key switches the screen in the reverse direction.

When the remaining sampling start time becomes “0.00”, the pump starts operating.

When you press the START/STOP key in the operation standby mode, the operation is canceled, the operation display LED goes off, and the screen returns to the initial operation mode screen (flow rate setting screen).

When you press the DOWN key while holding down the MODE key in the operation standby mode, the key icon is displayed and the START/STOP key is disabled.



You can check the items shown on the previous page with the UP/DOWN key.

To cancel this mode, press the DOWN key while holding down the MODE key. The key icon disappears and the START/STOP key is enabled.

4.8.8 During sampling

When using the down timer and volume timer, the operation display LED blinks in green and blue during sampling, respectively. The pump operation mark is lit and the instantaneous flow rate is displayed.

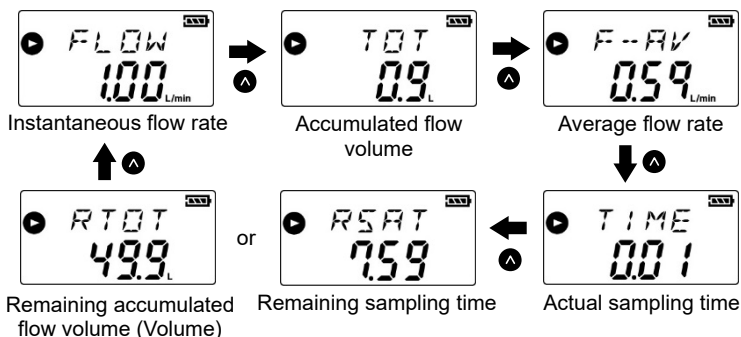

Pressing the UP key during sampling switches the screen cyclically: accumulated flow volume, average flow rate, actual sampling time (elapsed time), remaining sampling time or remaining accumulated flow volume, and instantaneous flow rate.



Pressing the DOWN key switches the screen in the reverse direction.

When you press the DOWN key while holding down the MODE key during pump operation, the key icon is displayed and the START/STOP key is disabled.



You can check the items shown above with the UP/DOWN key. To cancel this mode, press the DOWN key while holding down the MODE key. The key icon disappears and the START/STOP key is enabled.

When the set time elapses or the accumulated flow volume reaches the set level, the pump stops and the accumulated flow volume screen is displayed. For details, see the section "After end of sampling". (See page 29.)



The sampling can also be stopped forcibly by pressing the START/STOP key.

Note: If an error occurs, the error screen is displayed, the backlight turns white, and the operation display LED blinks in red.

For details, see the section "After end of sampling". (See page 29.)

When you hold down the MODE key on any screen during operation, the present electric current value is displayed. The unit is mA.

When you press the MODE key again or when one minute elapses, the screen returns to the previous screen.

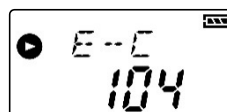

4.8.9 Pause Function

When you press the MODE key during sampling, sampling stops, and the pump pauses. While paused, the down timer and volume timer counts stop, and the pause continues even if you turn OFF the power to the pump body. Accordingly, the battery can be replaced during this time.

⚠ CAUTION

Be sure to turn OFF the power to the pump body before removing or mounting the battery. Failure to follow this instruction might cause a failure or electric shock.

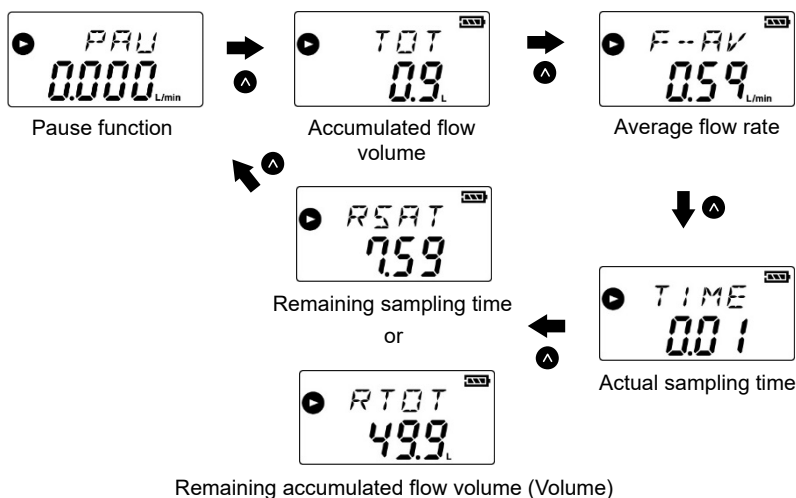

Pressing the UP key while paused switches the screen cyclically: accumulated flow volume, average flow rate, actual sampling time (elapsed time), remaining sampling time or remaining accumulated flow volume, and the pause screen.

When you press the DOWN key while holding down the MODE key during a pause, the key icon is displayed, and the START/STOP key is disabled.



You can check the items shown above with the UP/DOWN key. In addition, the key icon remains displayed even if you turn ON the power again. To cancel this mode, press the DOWN key while holding down the MODE key. The key icon disappears and the START/STOP key is enabled.

To restart sampling when paused, press the START/STOP key. After restarting, the pump continues from before the pause. When the set time or accumulated flow volume is reached, the pump stops, and the accumulated flow volume screen is displayed.

For details, see the section “After end of sampling”. (See page 29.)



The sampling can also be stopped forcibly by pressing the START/STOP key.

To stop sampling as is after pausing, press and hold the MODE key for 5 seconds or longer. This displays the accumulated flow volume screen and cancels the pause function.

Note: While the pause function is operating, it continues even if you turn ON the power again. To switch to another mode, press the START/STOP key or the MODE key. This cancels the pause function.

4.8.10 After end of sampling

When the sampling ends, the pump stops and the actual accumulated flow volume screen is displayed.

Note: If an error occurs, the error screen is displayed, the backlight turns white, and the operation display LED blinks in red.

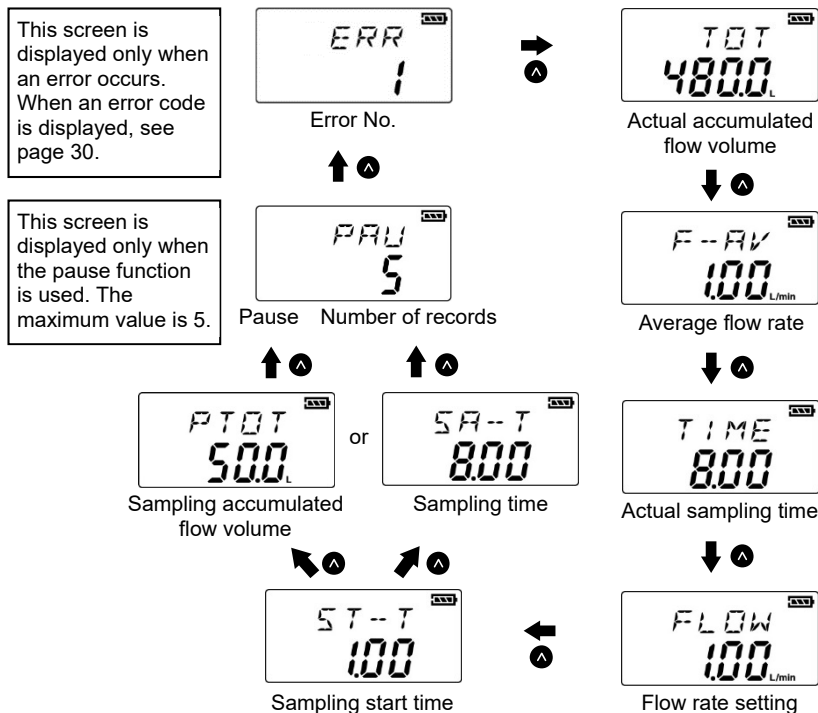

Pressing the UP key switches the screen cyclically: average flow rate, actual sampling time, each setting screen, and actual accumulated flow volume. Pressing the DOWN key switches the screen in the reverse direction.



All of the number of pauses, error No., actual accumulated flow volume, average flow rate, and actual sampling time are called "last data" and the last sampling results are displayed. The last data is the same as "LOG 0" of the memory function. Pressing the UP/DOWN key will return to the normal screen, such as the flow rate setting screen.

When an error code is displayed, see page 30.

4.9 Error

Immediately stop operation if an error occurs during pump operation.

If an error occurs, the error No. is displayed, the backlight turns white, and the operation display LED blinks in red.

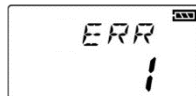

Error No. and meaning		Cause	Corrective action
1	The difference between the set flow rate and the instantaneous flow rate has exceeded the set threshold (± 4 to 20 %). (See page 39.)	When the load is strong and the intake pressure is high, the flow rate does not reach its set level.	Reduce the load.
		Completely different flow rate is displayed.	The pump may malfunction. Contact your Sibata agent.
2	The power voltage has fallen below 5.4 V.	The battery has been exhausted.	Replace the dry cells with new ones or charge the nickel metal-hydride battery.
		The power switch was turned OFF.	Turn ON the power switch again.
3	The motor current consumption has reached or exceeded 500 mA.	The load may be strong and the intake pressure may be high.	Reduce the load.
4	The temperature has exceeded 60°C.	The temperature has exceeded the operating temperature range.	Restart the operation after the temperature has dropped.
5	The atmospheric pressure has become 600 hPa or less.	The altitude is too high.	Use the product in a place with a lower altitude.

These error numbers are also recorded in the log.



When “ERR 2” occurs, the power may turn OFF and the display disappears. When the power is turned back ON in this case, the backlight turns white, the operation LED blinks in red, and “ERR 2” is displayed. At this time, pressing any button will display the normal screen, allowing you to restart the operation. When turning OFF the power without pressing any button, “ERR 2” is displayed again after turning ON the power again.

4.10 Numeric value overrun

If the accumulated flow volume, sampling time, or instantaneous flow rate exceeds its specified numeric value during operation, the caution screen shown below is displayed.

4.10.1 Accumulated flow volume

When the accumulated flow volume exceeds 999.99 L, the number of display digits is incremented by 1. Furthermore, when the accumulated flow volume exceeds 9999.9 L, the number of display digits is incremented by 1.

When the accumulated flow volume exceeds the maximum display value of 99999 L, the OVER icon and numeric value "99999" blink. The mini pump continues to operate, however, numeric values are not incremented and the accumulated flow volume cannot be measured. At this time, the average flow rate value also cannot also be measured.

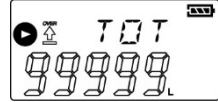

4.10.2 Sampling time

When the sampling time exceeds 999 hours and 59 minutes, the OVER icon and the numeric value blink. The mini pump continues to operate, however, numeric values are not incremented and the sampling time cannot be measured.

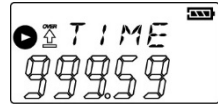

4.10.3 Instantaneous flow rate

When the instantaneous flow rate exceeds 6.50 L/min, the OVER icon and the numeric value blink. The mini pump continues to operate, however, the numeric value is defined as 6.50 L/min. (The average flow rate and accumulated flow volume may deviate.)

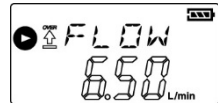

4.11 Calibration

LCD notation  ... Blink  ... Lit

To perform highly accurate measurements, calibrate the mini pump with collected matter, such as a collector connected to the intake port.

Prepare a buffer tank and flow calibrator as shown in the figure below.

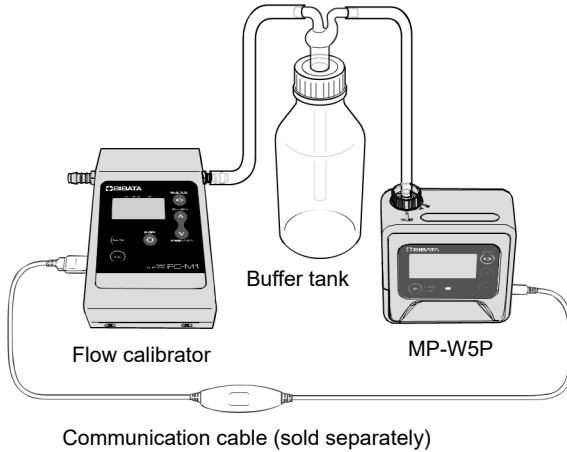

At this time, when using Sibata's flow calibrator FC-M1, you can calibrate the mini pump more easily. Additionally, use of the flow calibrator FC-M1 and communication cable (sold separately) makes it possible to perform the following work automatically.

The operation display LED blinks in light blue during automatic calibration. You do not need to operate the mini pump during automatic calibration.

For details, see the Operation Manual for flow calibrator FC-M1.

Press the MODE key until the CAL screen is displayed.
When you press the START/STOP key on this screen, the screen moves to the FADJ screen.

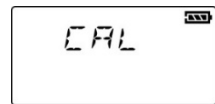

The latest 1-point calibrated flow rate is displayed on the FADJ screen. No numeric value is displayed in the state if 1-point calibration has not been performed, such as at the time of factory shipment.

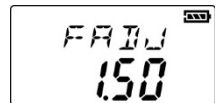

Note: The calibration method used here is 1-point calibration. So, the accuracy may deviate with other flow rates. To return to the original state, return the mini pump to its factory shipment state. (See page 38.)

Press the START/STOP key in the FADJ screen. The display of the flow rate conversion temperature starts to blink. The value can be switched between 25°C, 20°C, and 0°C by pressing the UP/DOWN key. Pressing the MODE key on this screen will cancel the calibration and return to the CAL screen.

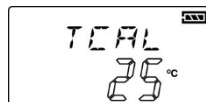

After setting the flow rate conversion temperature, press the START/ STOP key. The display of the flow rate starts to blink. Set the flow rate to be calibrated by pressing the UP/DOWN key.

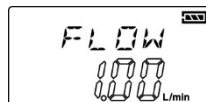

When you press the START/STOP key, the pump starts operating after zero offset. The operation display LED blinks in red, the pump operation icon blinks, and the pump enters the state in which it does not accept any operation for 1 minute.

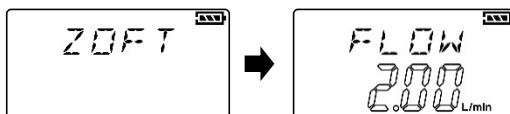

When the operation display LED blinks in green and the pump operation icon turns lit, perform the measurement with the flow calibrator.

When the measurement is complete, press the START/STOP key to stop the pump.

Adjust the flow rate value to the numeric value displayed on the flow calibrator with the UP/DOWN key.

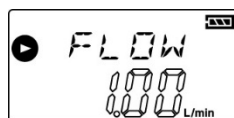

After that, when pressing the START/STOP key, END is displayed, and then the screen returns to the CAL screen.

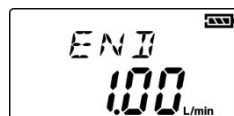

IMPORTANT	Do not turn OFF the power during calibration. Doing so may cause a failure.
------------------	---

	<p>Before starting the calibration, perform the warm-up operation of the MP-W5P for several minutes.</p> <p>The accuracy may deviate immediately after turning ON the power.</p>
---	--

4.12 Memory

Press the MODE key until the MEM screen is displayed. In this screen, you can view the past data (logs) by pressing the START/STOP key.



“LOG 0” is displayed in the initial screen. Pressing the MODE key displays the next log. You can view the past data for up to ten operation cycles (up to LOG 9) as long as the logs are recorded.

The date on this screen shows the date when the pump operation is started.

Note: If no logs remain even when the pump is operated, contact your Sibata agent.

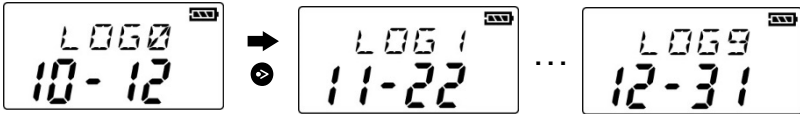

Pressing the UP key on each log screen switches the screen cyclically: flow rate setting, error (not displayed when no error occurs), accumulated flow volume, average flow rate, sampling time, sampling start date, sampling start time (1st pause start date, 1st pause start time, 1st pause end date, 1st pause end time...5th pause end time (not displayed when none)), sampling end date, and sampling end time. Finally, the screen returns to the log screen.

Pressing the DOWN key switches the screen in the reverse direction.

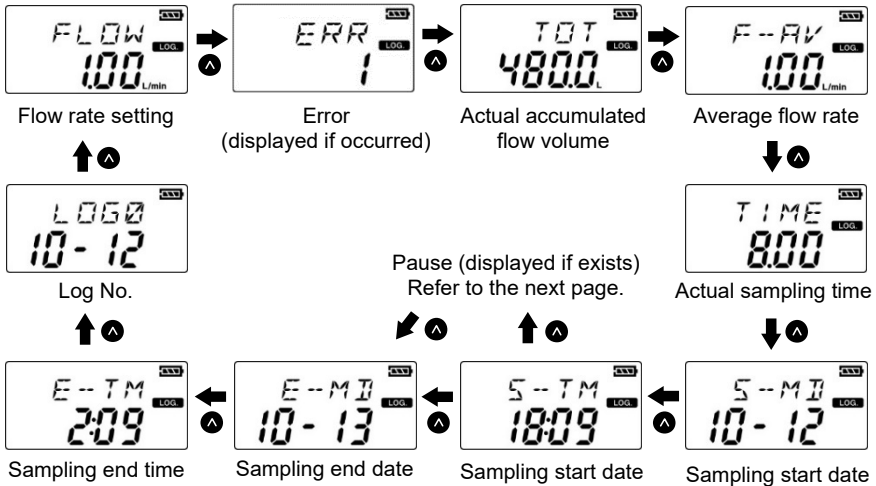

1st pause

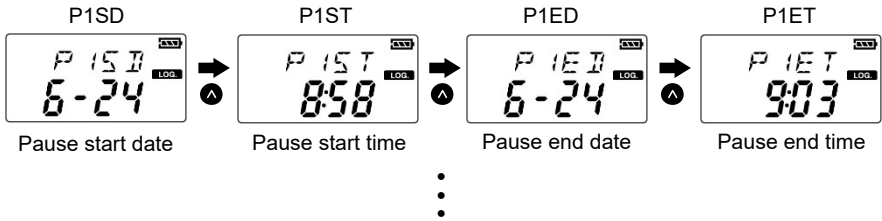

5th pause

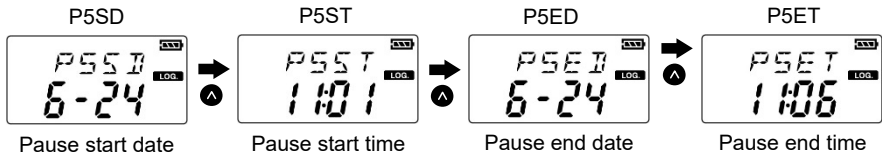

Pressing the START/STOP key on any screen will return to the MEM screen. Note that you can view the logs for up to ten operation cycles on the mini pump. The last data that is displayed immediately after the pump has stopped is the same as LOG 0.

4.13 Extra menu

LCD notation  ... Blink  ... Lit

Press the MODE key until the EXTR screen is displayed. When you press the START/STOP key on this screen, the operation enters the extra menu and the clock (time) is displayed.

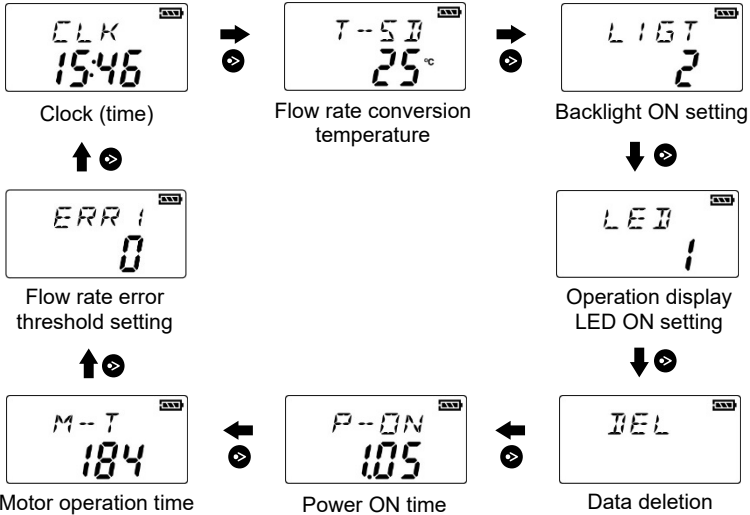
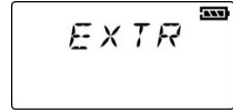

Pressing the MODE key switches the screen cyclically: flow rate conversion temperature, backlight ON setting, operation display LED ON setting, data deletion, power ON time, motor operation time, flow rate error threshold setting, and then clock (time).

4.13.1 Clock

Pressing the UP key in the clock (time) screen switches the screen cyclically: time, year, date.

Pressing the DOWN key switches the screen in the reverse direction.

Pressing the MODE key in any of the screens changes the screen to the flow rate conversion temperature.



The clock can be set by holding down the MODE key in the respective screen. The value that can be set blinks. Set the value by using the UP/DOWN key.

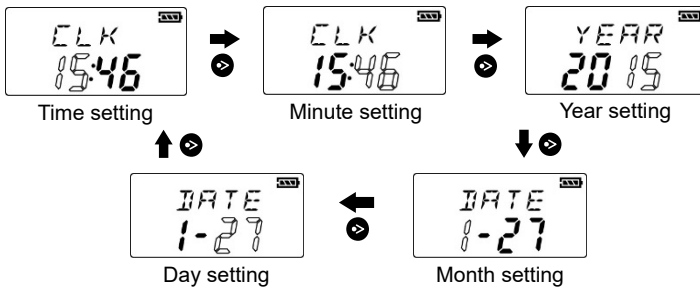

Pressing the MODE key switches the screen cyclically as follows: time, minutes, year, month, day, time. In each of the relevant screens, press the START/STOP key. The display value lights up, and the setup is complete.

Note: If the time deviates greatly or cannot be set after the clock is set, contact your Sibata agent.

4.13.2 Flow rate conversion temperature

The flow rate conversion temperature is displayed. The default temperature is 25.0°C. Hold down the MODE key, and the value blinks.

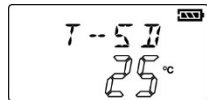

The flow rate conversion temperature can be changed to 25°C, 20°C, 0°C, or actual flow rate (A is displayed) by pressing the UP/DOWN key.

When you press the START/STOP key on the relevant screen, the display value turns lit, and the setup is complete.

4.13.3 Backlight ON setting

The conditions for lighting up the backlight can be set. The default is 2.

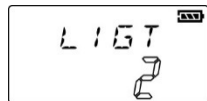

Holding down the MODE key causes the value to blink. The value can be changed in a range from 0 to 2 by pressing the UP/DOWN key.

- 0: Always off
- 1: Always lit
- 2: Goes off when no button is pressed for 30 seconds.

In each of the relevant screens, press the START/STOP key. The display value lights up, and the setup is complete.

Note: If the operation display LED setting is "1 (ON)", the backlight blinks regardless of the above-mentioned setting when an error occurs and the pump switches to the error screen.

4.13.4 Operation display LED ON setting

The operation display LED lighting state can be set.

The default value is 1.

When you hold down the MODE key, the value blinks.

The value can be changed to 0 or 1 by pressing the UP/DOWN key.

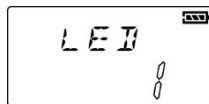

0: OFF (LED does not light up on each item. The backlight no longer blinks when an error occurs.)

1: ON

In each of the relevant screens, press the START/STOP key. The display value lights up, and the setup is complete.

4.13.5 Data deletion

The log data (memory) of the mini pump can be deleted to return to the default settings (factory shipment settings).

After displaying the DEL screen, pressing the UP key switches the screen cyclically: DATA screen, DFLT screen, and DEL screen. Pressing the DOWN key switches the screen in the reverse direction.

Pressing the MODE key on each screen will move to the power ON time screen.

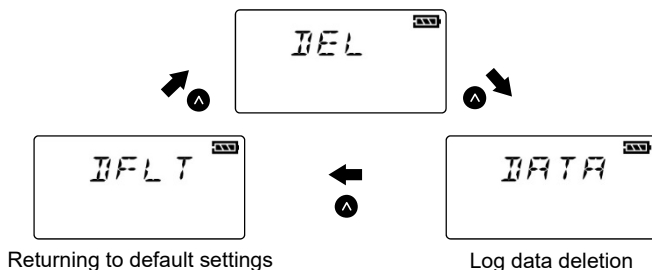

The DATA screen is intended to allow all the registered log data to be deleted.

The DFLT screen is intended to allow the pump set values to be returned to the default settings.

When you hold down the MODE key on each screen, the character string "PUSH START KEY" scrolls.

Pressing the MODE key on this screen will cancel the operation.

Pressing the START/STOP key will execute the process you have selected.

When END is displayed, the process is complete.

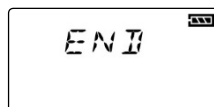
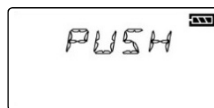

IMPORTANT	Be aware that the logs or settings cannot be restored once they are deleted.
	When the settings are returned to the default settings, the flow rate calibration value (see page 32) is also returned to the default state.
	Do not turn OFF the power during data deletion. Doing so may cause a failure.
	Do not remove the battery during pump operation.
	Note that even if a failure occurs, Sibata shall not be held responsible for any compensation for the contents of any data that was not acquired or recorded, any lost data, and other direct, indirect, or consequential damages resulting from this failure.

4.13.6 Power ON time

The elapsed time after powering ON the mini pump is displayed.

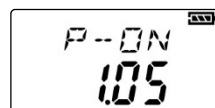

4.13.7 Motor operation time

The total operation hours of this mini pump are displayed. The unit is hours. The service life of the motor is about 2,000 hours. When the total operation hours exceed 2,000 hours, take the maintenance work into consideration.

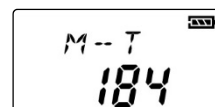

Note: The service life of the motor may be reduced depending on the operating environment.

4.13.8 Flow Rate Error Threshold Setting

The difference threshold for a flow rate error (ERR1) can be changed.

The default value is 0 ($\pm 20\%$).

When you hold down the MODE key, the value blinks.

Pressing the UP/DOWN keys switches the value cyclically: 0, 4, 5...19, 0.

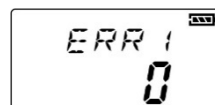

0: The difference between the set flow rate and the instantaneous flow rate is within $\pm 20\%$.

4 to 19: The difference between the set flow rate and the instantaneous flow rate is within ± 4 to 19 %.

In each of the relevant screens, press the START/STOP key. The display value lights up, and the setup is complete.

5 Troubleshooting

Symptom	Cause	Corrective action
No display after power ON	The battery is not mounted.	Mount the NI-W5 nickel metal-hydride battery or six AA dry cells using the SN3-6B battery holder. Or, operate the mini pump with an AC power supply.
	The battery capacity of the NI-W5 nickel metal-hydride battery drops.	Charge the NI-W5 with the QCA-W5/QCA-W5SE quick charger.
	The dry cells become exhausted.	Use six new AA dry cells.
	The plug of the AC adapter comes off when using the AC power supply.	Connect the QCA-W5/QCA-W5SE quick charger to a 100 V AC outlet correctly. Additionally, check also the connector on the mini pump.
Display appears, however, the pump does not operate or pump operation is inappropriate.	Liquid has been pumped in. *1	The repair or adjustment is needed. Contact your Sibata agent.
	The charge remaining in the battery is low and  is displayed on the screen (when the battery is used).	Replace or charge the battery. Or, operate the mini pump with the AC power supply.
Pump operates, but the flow rate does not increase or become stable.	The filter element is clogged.	Replace the VFE-2 filter element.
	The sampling tube is damaged.	Replace the tube.
		Change the tube connection method.
	The intake pressure is beyond the specified range.	Check if the intake pressure is within the specification range. (See pages 18 and 42.)
The diaphragm of the pump is broken. (The flow rate does not increase at all.)	This problem often occurs when a load is applied by accidental blocking of the exhaust port. The repair or adjustment is needed. Contact your Sibata agent.	
Pump stops during sampling.	As an error No. is displayed, check it. (See page 30.)	After removing the cause according to the error No., restart the operation. (See page 30.) If the pump is not recovered even after removing the cause, contact your Sibata agent.
Internal clock setting fails even though the internal clock has been set.	The battery for the clock that is mounted on the internal circuit board is exhausted. *2	The repair or adjustment is needed. Contact your Sibata agent.

Symptom	Cause	Corrective action
No logs in the memory.	The power switch was turned OFF immediately after the sampling was completed.	The repair or adjustment is needed. Contact your Sibata agent.
Backlight does not turn ON.	The backlight was set so that it stays OFF.	See the backlight ON setting on the extra menu. (See page 37.)
Operation display LED does not turn ON.	The operation display LED is set so that it stays OFF.	See the operation display LED ON setting on the extra menu. (See page 38.)
When using the NI-W5 nickel metal-hydride battery that has finished charging, the battery quickly runs out.	<p>The NI-W5 nickel metal-hydride battery is over discharged.</p> <ul style="list-style-type: none"> ●The pump was stored with the power switch ON. ●The battery was not used for a long time. 	When the QCA-W5/QCA-W5SE quick charger is used to charge the NI-W5 and indicates that it is fully charged within 10 minutes, re-power the QCA-W5/QCA-W5SE, and charge it again. Also after it is charged, use the voltage confirmation function of the QCA-W5 and confirm that the charge has finished properly (See QCA-W5/QCA-W5SE operation manual).
	The life of NI-W5 nickel metal-hydride battery has expired.	Purchase and replace the NI-W5 nickel metal-hydride battery.

*1 The reverse connection of the impinger is a common example. Carefully check the piping. (See the section “When using an impinger” of “Installation and piping” on page 18.)

*2 The reference service life is 2 years.

6 Maintenance

6.1 Replacing the filter element

Visually check the filter element for contamination periodically. If the filter element is extremely contaminated extremely, for example, it is turning black, replace it with a new one.

For details about how to replace the filter element, see page 19.

6.2 About periodic inspection

To maintain the flow rate accuracy of this product, the periodic inspection (chargeable basis) is recommended. It is recommended that Sibata performs the inspection by Sibata once a year.

7 Specifications

7.1 Specifications

Model	MP-W5P
Operable flow rate range	0.050 to 5.00 L/min
Display range of instantaneous flow rate	0.000 to 6.50 L/min
Constant flow rate ranges	0.050 L/min : 0 to 7.0 kPa 0.100 to 2.00 L/min : 0 to 10 kPa 2.50 L/min : 0 to 9.0 kPa 3.00 L/min : 0 to 8.0 kPa 5.00 L/min : 0 to 3.0 kPa
Accuracy of constant flow rate	±5% or less or 5 mL/min. or less, whichever is larger.
Range of total flow volume setting	0.0 to 9999.9 L
Display range of total flow volume	0.00 to 99999 L
Display range of set time	0.00 to 999.59 (hour and minute)
Built-in flow meter	Differential pressure type
Pump type	Diaphragm type
Display	Liquid crystal display device (with backlighting)
Intake/exhaust port diameter	O.D. 6 mm and 8 mm (tube used: I.D. 5 mm and 7 mm)
Range of operating temperature/humidity	0 to 40°C 10 to 90%RH (no condensation)
Electric power source	NI-W5 nickel metal-hydride battery Six AA dry cells, AC power supply (100 to 240 V)
Operating time (NI-W5 is used in the no-load state.)	0.1 L/min: over 24 hours 1.0 L/min: over 18 hours
Dimensions	W 95 × D 56 × H 95 mm (excluding protrusions)
Weight	0.45 kg (including nickel metal-hydride battery)

Note:

- The operable flow rate range, constant flow rate range, and accuracy of constant flow rate stated above are intended for 1 atmospheric pressure. The pump may not provide optimal performance in a place where the altitude is high and the atmospheric pressure is low.
- The operating time is a reference value used at 25°C. This value may vary depending on the ambient temperature for operation, operation history, or intake pressure to be used.
- When the flow rate is less than 0.1 L/min., the instantaneous flow rate display may deviate from the flow rate accuracy or more momentarily.
- The pump does not show the performance shown above immediately after turning ON the power. Start the operation after performing the warm-up operation for several minutes.

List of materials used

Part name		Material
Case		PC
Flow path	Resin	PC, ABS
	Rubber	EPDM, Si, NBR
	Metal	SUS304
Internal parts		PC, ABS, POM
Metal		SUS304, C3604CdL, iron
Others		Glass epoxy for electronic parts and circuit boards

7.2 Accessories and Products Sold Separately

Item code	Part name
080860-5053	Three-color cap, red, blue, yellow (Not subject to RoHS directive)
080860-5051	NI-W5 Nickel metal-hydride battery (Not subject to RoHS directive)
080860-5052	SN3-6B Battery holder for MP-W5P (Not subject to RoHS directive)
090860-50641	QCA-W5SE Quick charger (Not subject to RoHS directive)
080870-59	UES18LCP AC adapter

7.3 Options and consumable parts

Item code	Part name
080860-5055	Soft case for MP-W5P (Not subject to RoHS directive)
080860-5056	Intake port set for MP-W5P (Not subject to RoHS directive)
080860-5057	VFE-2 Filter element, 5 pcs. (Not subject to RoHS directive)
080860-58	Connection cable LI-10N for MP-W5P (Not subject to RoHS directive)
080860-59	A set of two types of communication cables for MP-W5P and ΣNII (Not subject to RoHS directive)
080840-53	Impinger Holder for MP (Not subject to RoHS directive)

7.4 About operating sound

The operating sound of this product is 65 dB or less in the normal operating state. No particular protective gear, such as earplugs, is required.

Noise measurement results

0.1 LPM	No-load operation	30 dB or less
1 LPM	No-load operation	45 dB or less
5 LPM	No-load operation	65 dB or less

Measured at a distance of 30 cm from the pump in an environment at 1 atmospheric pressure and 25°C.

However, note that these numeric values are not guaranteed.

8 LCD Screen List

		Normal screen
CAL	Calibration screen	Screen for entering the calibration mode
CLK	Time	Displays the time.
DATA	Log deletion screen	Displays all deleted log records.
DATE	Date	Displays the date.
DEL	Deletion screen	Displays log deletion records and default settings
DFLT	Default settings	Indicates that the settings are returned to the default settings.
E-C	Current value	Displays the current consumption.
END	End	Displays that the data deletion is complete.
ERR	Error No.	Displays an error. Displays the error contents using the error No.
ERR1	Flow rate error threshold setting	Displays the flow rate error threshold setting.
EXTR	Extra menu	Menu for entering various setup menus (e.g., clock setting).
FADJ	Flow rate calibration screen	Displays flow rate calibration.
F-AV	Average flow rate	Displays the average flow rate during sampling.
FCAL	1-point calibration flow rate	1-point calibrated flow rate
FLOW	Flow rate setting, instantaneous flow rate	Displays the set flow rate before measurement and the instantaneous flow rate during measurement.
LED	Setting of operation display LED	Displays the LED ON setting.
LIGT	Backlight ON setting	Displays the backlight ON setting.
LOG 0 to 9	Log No.	Displays each log by the respective number in the log screen.
MEM	Past log menu	Menu for entering the log menu
M-T	Motor operation time	Displays the continuous motor operating time of this product.
PAU	Pause screen, member of pauses	Displays the pause screen during sampling, and the number of pauses after sampling is finished.
PMAX	Max. absolute pressure	Max. absolute pressure value during sampling
PMIN	Min. absolute pressure	Min. absolute pressure value during sampling
P-ON	Power ON time	Displays the time when the power has been turned ON.
PTOT	Volume timer setting	Displays the accumulated flow volume set by the volume timer.
RSAT	Remaining measurement time	Displays the remaining time before the end of the sampling.
RTOT	Remaining measurement volume	Displays the remaining accumulated flow volume before the end of the sampling.
SA-T	Set sampling time	Displays the preset sampling time.
ST-T	Set sampling start time	Displays the preset sampling start time.
T-AV	Average temperature	Average temperature value during sampling
TCAL	Flow rate conversion temperature during calibration	Displays the flow rate conversion temperature during flow rate calibration.
TIME	Actual sampling time	Displays the actual sampling time.
TMAX	Average temperature	Max. temperature value during sampling
TMIN	Average temperature	Min. temperature value during sampling
TOT	Accumulated flow volume	Displays the actual accumulated flow volume value.
T-SD	Flow rate conversion temperature display	Displays the temperature conversion value of the flow rate.
VER	Version information	Displays the version information of this product.
WAIT	Remaining measurement start time	Indicates the measurement standby state and displays the remaining time before the start of the measurement.
YEAR	Year	Displays the year using the Western calendar.
ZOFT	Zero offset	Indicates that zero offset is being performed during the flow rate calibration.

9 Warranty and Repair

If Sibata's product malfunctions within one year from the purchase date, Sibata shall repair the defective product free of charge.

When the product needs to be repaired, contact your Sibata agent. Note that the consumable parts supplied with the product are outside the warranty coverage. If the cause of the problem is any of the following, the product is also outside the warranty coverage and it is repaired on a chargeable basis.

- Problems or defects arising from incorrect operation performed by the customer.
- Problems or defects arising from repairs or modifications performed by personnel other than Sibata's authorized engineers.
- Problems caused by abuse or inadequate maintenance.
- Problems or defects arising from acts of God, such as fire, earthquake, and other natural disasters.
- Problems or defects arising from transfer, relocation, falls, or vibration after purchase.
- Problems or defects arising from the use of consumable parts other than those specified by Sibata.
- The purchase date was not indicated or the seller's stamp was not placed on the warranty document, or the description contents were corrected.

■ Requesting the Repair of Products Used in Environments Exposed to Asbestos (Request)

In order to prevent harm to customers and repair staff due to asbestos exposure, we would like your cooperation when you request the repair of products that have been used in environments exposed to asbestos. Please read the following before requesting repairs.

1. Remove any asbestos from the product before sending it for repairs. After removing the asbestos, place the product and any accessories in a double-sealed, transparent, waterproof material (such as a strong plastic bag) and pack it in a box. When sealing the bag, make sure that the product serial number and the number of accessories can be confirmed from the outside.
2. Write "AS" clearly in the "Fault Description and Request Details" column of the "Repair Request Form".
If there is no such description with the product, you may be asked by our sales representative to confirm whether there was any asbestos exposure.
3. When the product to be repaired is sent to us by courier, then, in addition to the model number, add "AS" to the "Comments" or "Description" section of the invoice. This measure is to prevent damage to the sealed bag when the package is unpacked with a cutter.

Note: The above request is applicable to all similar products related to asbestos measurement.

LIMITED WARRANTY

If some nonconformity occurs during use of this product, Sibata does not assume any liability whatsoever for compensation of data or content that could not be acquired or logged as a result, loss of data or other content, and other direct and indirect damages (loss of business profit, interruption of business, etc.) relating to the preceding.

Sibata guarantees repair of production malfunctions under fixed conditions. However, Sibata does not offer any compensation for loss of or damage to data stored on the product. When asking Sibata for repair or other services, make a backup of any required data. Sibata does not assume any liability whatsoever for any damages that may occur accompanying loss or discarding of data due to infringement of precautions described in this manual or neglect to back up data on the part of the customer.

For details of repair after the warranty has expired, contact your Sibata agent. The product shall be repaired for a fee only if Sibata judges that repair shall restore its functions, and its functions can be sustained in the future only in accordance with the specified methods of use.

When returning this product for repair, fill in the Problem Notification Sheet and send this sheet together with this product. (See page 47.)

10 Disposal of the Product

The pump body is mainly composed of plastic parts (polycarbonate and ABS). Dispose of the pump body and its accessories according to the disposal method defined by each municipality.

Additionally, be sure to take out the nickel metal-hydride battery or dry cells from the pump body when disposing of the product.

The kind of categorization of the waste dry cell may vary depending on each municipality, including, recyclable waste, non-combustible waste, or toxic or harmful waste. Therefore, the waste disposal method also varies. Follow the instructions provided by the city, town, or village where you reside when disposing of waste dry cells.

For details about how to dispose of the nickel metal-hydride battery, see page 15.

11 Inquiries

If you have any questions about this product, or if there is any other way in which we can be of assistance, contact your Sibata representative.

12 Problem Notification Sheet

This sheet is to be filled in with the information required for the smooth checking and repair of pump malfunctions.

Please take a copy of this Problem Notification Sheet and write as much information on the problem as possible.

In addition, attach this sheet when asking for repair. Please fill in the cautions when sending the pump for repair and the required cleaning details.

[Work Check Items When Asking for Repair]

- : Make a copy of the Problem Notification Sheet, fill it in and send it together with the pump.
- : If there is a risk that harmful substances (e.g., asbestos) have been sucked into the pump, put this Problem Notification Sheet in an envelope, and attach it to the outside of the box. At that time, be sure to clearly indicate the presence of such substances on the Problem Notification Sheet.
(To perform asbestos sampling, please follow the "Requesting the Repair of Products Used in Environments Exposed to Asbestos (Request)" on page 45.)

MP-W5P Mini Pump Problem Notification Sheet

If the pump malfunctions, make a copy of this sheet, fill it in and contact your Sibata agent.

Entry Date: (yy/mm/dd)

[Product operation conditions]

Serial No. Date of Purchase: (yy/mm/dd)

Start date of operation: (yy/mm/dd)

Frequency of Use

: Every day : ____ days/week : ____ days/month : ____ hours/day

Operating Environment Temperature (measured temperature, if possible): ()°C to ()°C

Number of Installed Units: ____ units

Application:

[Symptoms of Malfunction]

Frequency of Occurrence : Every time : Occasionally : Rarely : Other ()

Start of Malfunction : Since purchase : Within a month : Within a week
: Other ()

Symptoms: (Write in as much detail as possible.)

Ex: The backlight does not turn ON when the relevant key is pressed.

[Check Items] (Please choose the relevant answer.)

- Does the LCD display turn ON when the power to the pump body is turned ON? (Yes · No)
- How contaminated is the filter element? (Contaminated · Not so contaminated)
- Has the pump sucked in liquid such as water? (Yes · No)
- Are there any signs or scratches on the pump body indicating that it has been dropped or subject to impact? (Yes · No)

SIBATA SCIENTIFIC TECHNOLOGY LTD.



1-1-62, Nakane, Soka, Saitama, 340-0005, Japan

TEL:+81-48-933-1582 FAX:+81-48-933-1591

E-mail:overseas@sibata.co.jp

<https://www.sibata.co.jp/en/>

Note: Due to product improvements, the product shape, dimensions, specifications, and other product information are subject to change without notice, to the extent that they do not affect product applicability or functionality.