



Flow Calibrator FC-M1

OPERATION MANUAL

Read this operation manual before using the product.



Thank you for purchasing this product.

- This operation manual describes precautions that are important for preventing accidents as well as procedures used to handle the product.
- Read this operation manual and the attached warranty thoroughly before use, and use the product correctly.
- After reading this operation manual and the warranty, keep them handy for future reference.

Table of Contents

Before Use	4
Safety Precautions	5
1 Product Overview	9
2 Features	9
3 Names of Parts	10
4 Measurement	12
4-1 Measurement Site	12
4-2 Checking the Power Supply	12
4-3 Confirming the Flowrate Conversion Temperature Setting	12
4-4 Checking the Battery Level Indicator	13
4-5 Auto-Zero Function (Zero Flowrate Check)	13
4-6 Starting Measurements	13
5 Menus	14
5-1 Main Screens	14
5-2 [MENU] Screen	15
5-3 Flowrate Conversion Temperature Setting	15
5-4 Accumulation Time Setting	16
5-5 Temperature Display Mode Setting	16
5-6 Pressure Display Mode Setting	17
5-7 Displaying the Software Version	18
5-8 Returning from a [MENU] Sub-Screen to the Main Screen	18
6 Calibration	19
6-1 Calibrating the Pressure Sensor	19
6-2 Calibrating the Temperature Sensor	20
6-3 Determining SPAN and ZERO Values by Calibration	21
6-4 Accumulated and Average Flowrate Display	21
6-5 Automatic Calibration	22
6-5-1 Preparation for Automatic Calibration	22
6-5-2 How to Perform Calibration Automatically	25

7	Storage	26
8	Maintenance	27
9	Troubleshooting	27
10	Summary of Error Screens.....	28
11	Specifications.....	29
12	Warranty and Repairs	30
13	Product Disposal.....	30
14	Inquiries	30
	Problem Report Form.....	31

Before Use

 WARNING	<ul style="list-style-type: none">• This product is not designed to be explosion-proof. To prevent explosion accidents, do not use it in dangerous locations.• Read this operation manual thoroughly before use, and use the product correctly.• Keep this operation manual handy for future reference.• Be sure to familiarize yourself with, and observe, the safety precautions given in this operation manual.• Observe usage procedures that are suitable for the product and that are specified in this operation manual. <p>Be sure to observe the above instructions. Not doing so may result in an accident or injury.</p>
--	---

■ About This Operation Manual

- Information in this operation manual is subject to change without notice in the interest of product improvement.
- Every effort has been made to ensure that the information in this operation manual is correct. If you discover any errors or omissions, however, please contact your Sibata representative.
- The copyright of this operation manual belongs to Sibata Scientific Technology Ltd. This operation manual, or any part thereof, may not be reproduced, reprinted, or altered in any form without prior written permission from Sibata Scientific Technology Ltd.

■ Checking Packaging Contents

(Please verify contents before using the product.)

- FC-M1 flow calibrator 1



- AA batteries (for checking operation) 4 pcs.
- Vinyl tubing, 7mm I.D. × 10mm O.D. 2.5 m
- Warranty 1
- Operation manual (Japanese, English) 1 for each
- Manufacture's Inspection Result 1
- Low-flowrate orifice adapter 1
(Vinyl tubing, 4mm I.D. × 7mm O.D. × 60mm 2 pcs., dedicated orifice and diameter adapter)

■ Items to Be Provided by the User

For calibrating MP-ΣNII series and MP-W5P mini pumps, provide a buffer tank, either currently available or purchased separately.

- Buffer tank (Sold separately: Item code 080880-1000)

Performing Automatic Calibration

It requires a set of two types of communication cables for MP-W5P/MP-ΣNII. However, a commercial A-mini B USB cable can be used for automatic calibration of MP-ΣNII series mini pumps.

- A set of two types of communication cables for MP-W5P/MP-ΣNII (Sold separately: Item code 080860-59)



Safety Precautions

The precautionary information in this operation manual is for ensuring that the product is used safely and for preventing injury to you and other people and damage to equipment. It is all important for ensuring safety, so be sure to read it thoroughly before using the product and observe it during use.

■ Graphical Symbols

This operation manual uses various graphical symbols to indicate warnings and instructions. These consist of two categories, **Warning** and **Caution**, which are indicated based on the severity of consequences if the corresponding warning or instruction is ignored and the instrument is operated improperly. Always observe these warnings and instructions, as they include important information about safety.

Labels Indicating Degrees of Damage or Injury

 WARNING	Indicates a potentially hazardous situation which, if not avoided, will result in serious injury or death.
 CAUTION	Indicates a potentially hazardous situation which, if not avoided, may result in injury or equipment damage.

WARNING

- Use dry cell batteries only. Do not use dry-cell shaped rechargeable batteries.
- Only connect the specified AC adapter and communication cable (both optionally available).
- Do not operate the instrument near highly flammable or combustible items. Doing so could cause explosion or fire.
- Keep the instrument away from open flames. Do not burn the instrument in a fire. Doing so could cause explosion or fire.
- This product is designed for indoor use. Do not get water or other liquids on the instrument. Doing so could cause a malfunction or fire.
- Use the instrument at an indoor location at an altitude of 2000 m or less.
- Do not subject the instrument to strong impacts or drops. Doing so could cause a malfunction or accident.
- Never attempt to disassemble or modify the instrument. Doing so could cause a malfunction or accident.
- If a problem occurs during operation, immediately stop operating the instrument, and remove the cause. If it is determined that the product caused the problem, switch the power OFF, remove the batteries or unplug the AC adapter from the power outlet, and then contact a Sibata representative. Never operate the instrument if it is not functioning normally. Also, never allow anyone other than a qualified service engineer to disassemble or modify the product. Doing so could cause a malfunction or accident.
- When connecting the AC adapter, ensure that the power plug can easily be inserted or removed from the outlet, and do not connect it to an outlet with multiple items sharing the same extension cord or plug adapter. Otherwise, an electric shock or fire could result.
- Check the AC adapter for cuts or other damage to the cable jacket before operating the instrument. Do not step on or place heavy objects on the cord. Operating the instrument under such abnormal conditions could cause a fire, electric shock, or other problems.
- Do not touch the AC adapter or outlet with wet hands. Doing so could result in an electric shock.



CAUTION

- This product is a flow calibrator. Do not use it for any purpose not indicated in this manual. Doing so could cause a malfunction.
- Do not wash the instrument directly in water. Doing so could cause an electric shock, fire, or malfunction.
- Do not place anything on top of the instrument. Doing so could cause a malfunction or accident.
- Remove the batteries (or unplug the power plug from the outlet if using the AC adapter) before cleaning or inspecting the instrument. Not doing so could cause an electric shock, battery leakage, or other problems.
The AC adapter is not protected against liquids, so do not clean it with ethanol.
- Unplug the AC adapter power plug from the outlet when the instrument is not in use. Not doing so could cause a fire or malfunction.
- If not using the instrument for an extended period, store it at normal room temperature in a dry location away from direct sunlight, with the AC adapter disconnected and batteries removed. Not doing so could cause battery leakage.
- Always grip the plug to unplug the AC adapter. Pulling on the cord could damage the cord and cause an electric shock or fire.
- Never attempt to connect to the connector using wire or other metal objects, or any other method not specified in this manual. Doing so could cause a malfunction.
- Do not permit water, other liquids, or non-atmospheric gases to enter the instrument. Also, do not permit salt air or other corrosive gases or chemicals to enter the instrument, either. Doing so could cause a malfunction or fire.
- Do not insert screws or other foreign objects into instrument gaps. Doing so could cause a malfunction. If a foreign object accidentally enters the instrument, immediately switch the power OFF and remove the batteries. Then contact your Sibata representative or the distributor where you purchased the product.
- The normal operating temperature range of this product is 0 to 40 °C, with humidity between 10 and 90 % RH (and no condensation). Operating the instrument outside these temperature and humidity ranges could reduce performance, shorten the service life, or cause a malfunction.
- Keep the instrument away from sources of noise. Also, do not place it in areas with strong magnetic fields, high dust levels, or high humidity. Doing so could cause instrument damage or other problems.

■ Caution Labels

Caution labels are affixed to the back of this product. During use, be sure to comply with the cautions noted.



 AVOID SHOCK	AVOID SHOCK Do not subject the product to strong impacts or drops. Doing so could cause a malfunction or accident.
 KEEP DRY	KEEP DRY Do not touch the outlet or the AC adapter plug with wet hands. Also, do not wash the product with water. Doing so could cause an electric shock, fire, or malfunction.

■ Pollution Degree and Overvoltage Category

The pollution degree and overvoltage category for this product are as follows.

Pollution Degree 2

Overvoltage Category II

1 Product Overview

The FC-M1 flow calibrator is able to measure flowrates between 0.050 and 5.000 L/min. The compact and easily portable design makes it easy to carry the unit to measurement sites for calibrating the flowrate of mini pump.

The product can be used to automatically calibrate Sibata MP-Σ30NII, MP-Σ300NII, MP-Σ500NII, MP-Σ100HNII, and MP-W5P model mini pumps.

2 Features

- Four modes are available for displaying flowrate: 25 °C at 1 atm, 20 °C at 1 atm, 0 °C at 1 atm, or actual volume.
- Flowrates under the above conditions do not require user calculation, because they are calculated internally.
- Measurement flowrate, temperature, and air pressure values are displayed on the LCD screen.
- The product can be used for automatic calibration, if used in combination with a Sibata MP-Σ30NII, MP-Σ300NII, MP-Σ500NII, MP-Σ100HNII, or MP-W5P model mini pump.
- In comparison with the previous FC-M1, a new accumulated flowrate display function has been added. As a result, it is possible to confirm the accumulated flowrate value either manually or when the configured time has ended.

3 Names of Parts

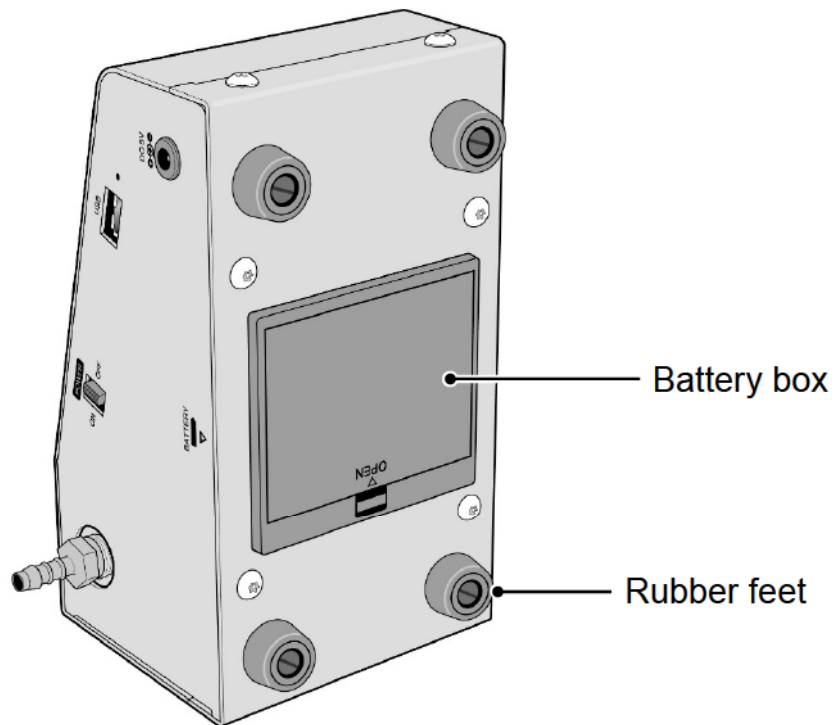
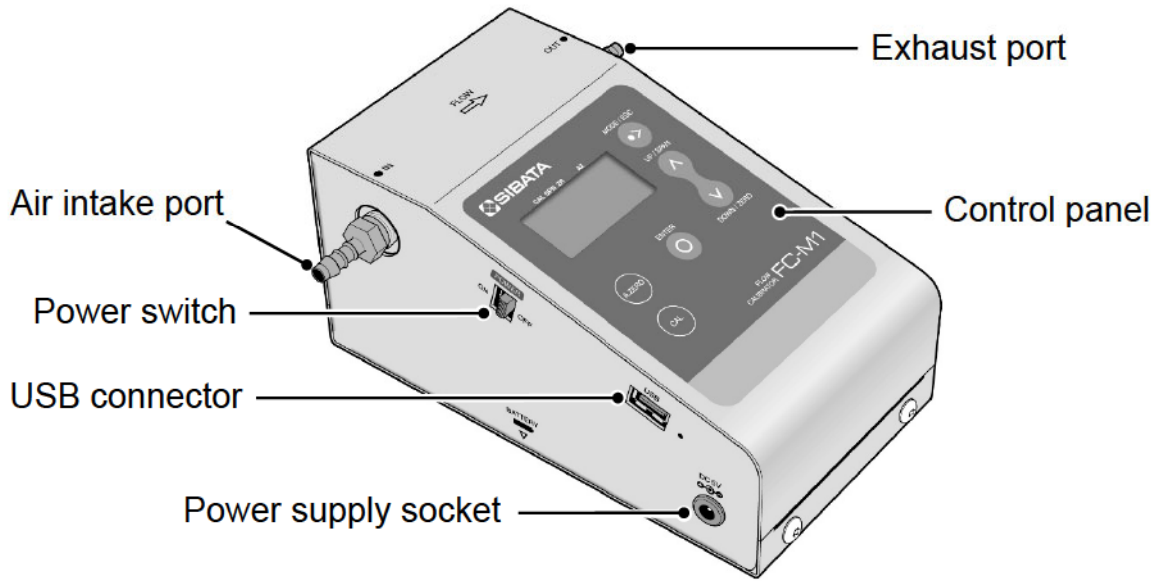

Control Panel

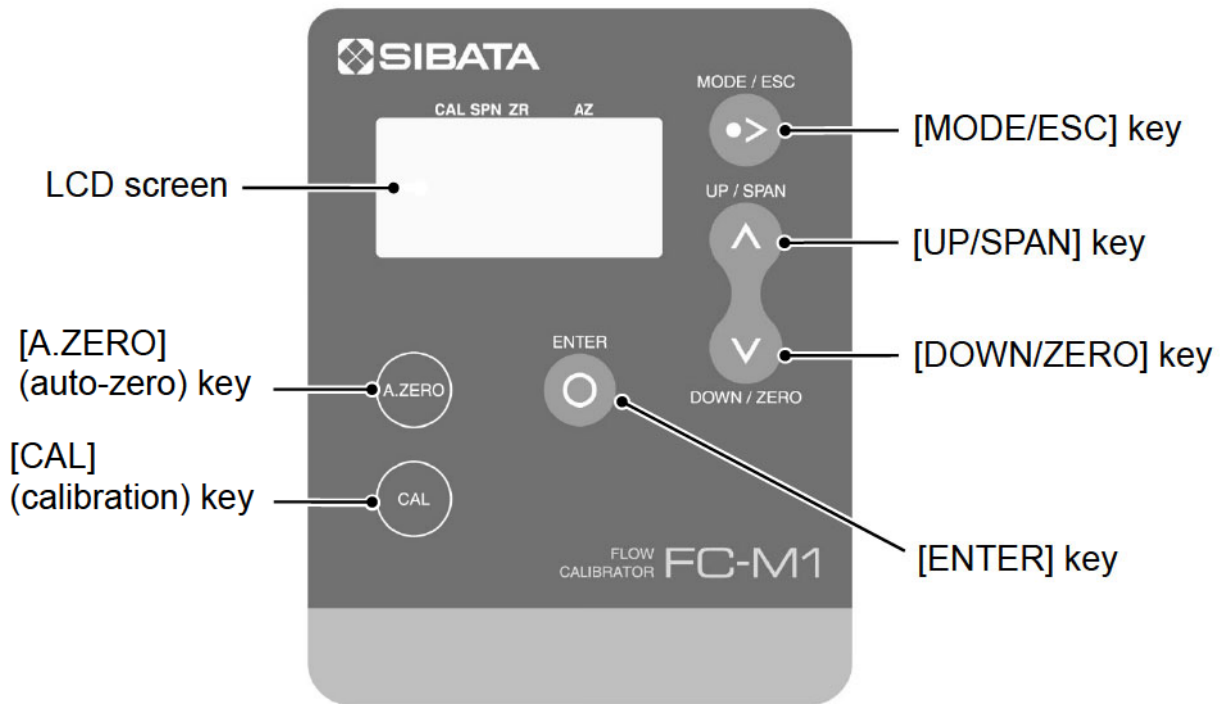

LCD Screen

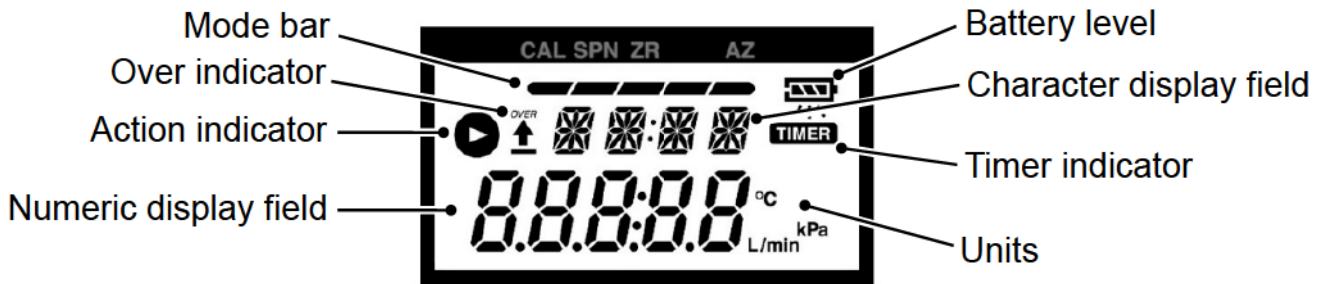

4 Measurement

4-1 Measurement Site

For precise measurements, perform measurements in a room (or thermostatic chamber) where temperature and humidity are controlled to constant levels. Note that the following types of sites are not appropriate for measurements.

- (1) Sites with a sloped floor
- (2) Sites with vibration
- (3) Sites exposed to direct sunlight
- (4) Sites where condensation could form
- (5) Sites with a large difference between hot and cold temperatures

4-2 Checking the Power Supply

If Powered by Batteries

The battery box is located on the bottom of the unit.
Remove the cover and install four AA size alkaline batteries.

Note: Use dry cell batteries only. Do not use dry-cell shaped rechargeable batteries.

If Powered by an AC Adapter (optional)

Connect the DC plug from the AC adapter into the power supply socket on the side of the main unit and plug the AC adapter into the power supply outlet.

If batteries are left installed when the AC adapter is connected, the system is powered by the AC adapter.

4-3 Confirming the Flowrate Conversion Temperature Setting

When the power supply is switched ON, the flowrate conversion temperature is displayed. To change the flowrate conversion temperature, press the [ENTER] key while the flowrate conversion temperature is still displayed (about 5 seconds). (For instructions on how to change the setting, see page 15.)

To not change the flowrate conversion temperature, either press the [MODE/ESC] key while the flowrate conversion temperature is displayed or switch to the main screen (flowrate measurement) after 5 seconds.

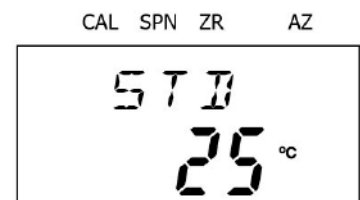

4-4 Checking the Battery Level Indicator

Check the remaining battery charge as follows.

A general guideline for the amount of remaining charge is indicated to the right.

This indicator is not displayed while the AC adapter is being used.

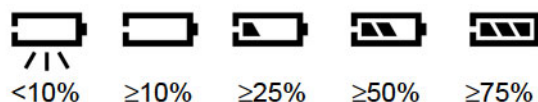

4-5 Auto-Zero Function (Zero Flowrate Check)

Let the instrument warm up at least 10 minutes after switching the power ON. After at least ten minutes have elapsed, press the [A.ZERO] key and confirm that the flowrate is 0.000 L/min. Make sure there is no air blowing when pressing the [A.ZERO] key.



The sensor used to measure flowrates requires time to stabilize the sensor output after the power is switched ON. Let the instrument warm up at least 10 minutes after switching the power ON. If not warmed up, it may not display correct flowrate values.

Note: To cancel the auto-zero function, hold down the [A.ZERO] key.

4-6 Starting Measurements

After confirming the items indicated in 4-1 to 4-5, connect the tube between the air intake port on the mini pump and the exhaust port on the FC-M1 flow calibrator. Then start operating the instrument.

Confirm the flowrate value indicated on the LCD display.

Note: It is also possible to display the accumulated or average flowrate value.

(For instructions on displaying the accumulated and average flowrate, see page 21.)

Values less than 0.050 L/min are not within the guaranteed precision range. (The indicated value flashes if below 0.040 L/min and is shown as 0.000 L/min for values below 0.020 L/min.)

5 Menus

LCD Screen
Status



The following describes the parameters that can be set or confirmed in respective flow calibrator menus.

5-1 Main Screens

The current air pressure*¹ and temperature can be confirmed by pressing the [MODE/ESC] key in the flowrate measurement screen.

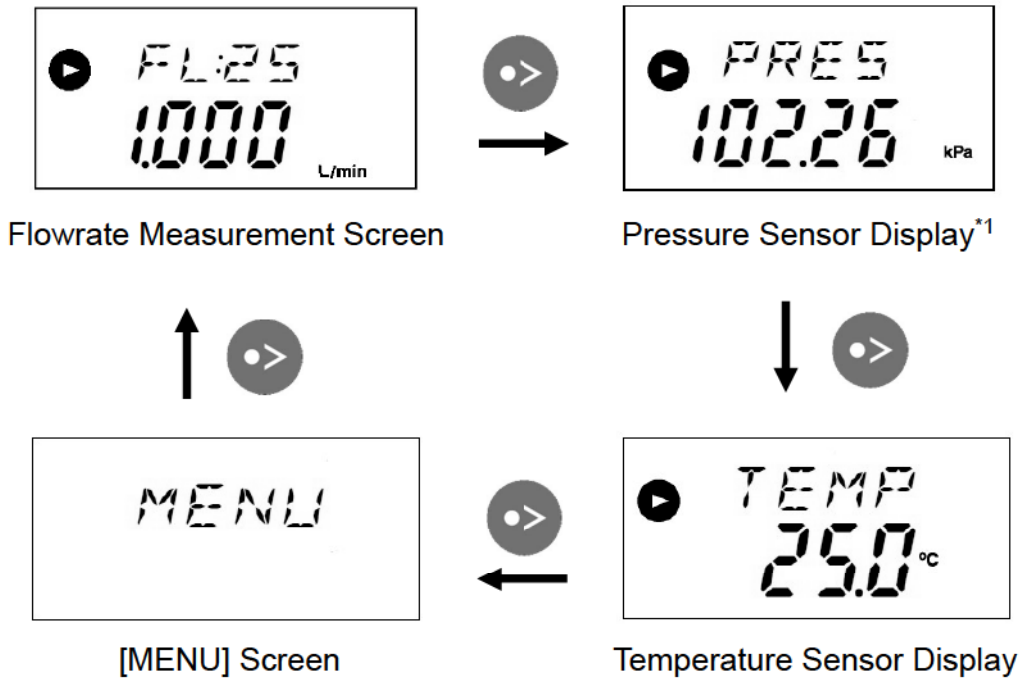

Note: It is possible to check the pressure and temperature even while measuring the accumulated and average flowrate.

*1 The atmospheric air pressure is indicated when no air is flowing, but the reference pressure (absolute pressure) at the flow calibrator air intake port is indicated if air is flowing.

A kPa is one tenth of a hPa.

5-2 [MENU] Screen

In the [MENU] screen, press the [ENTER] key to open the menu sub-screens.

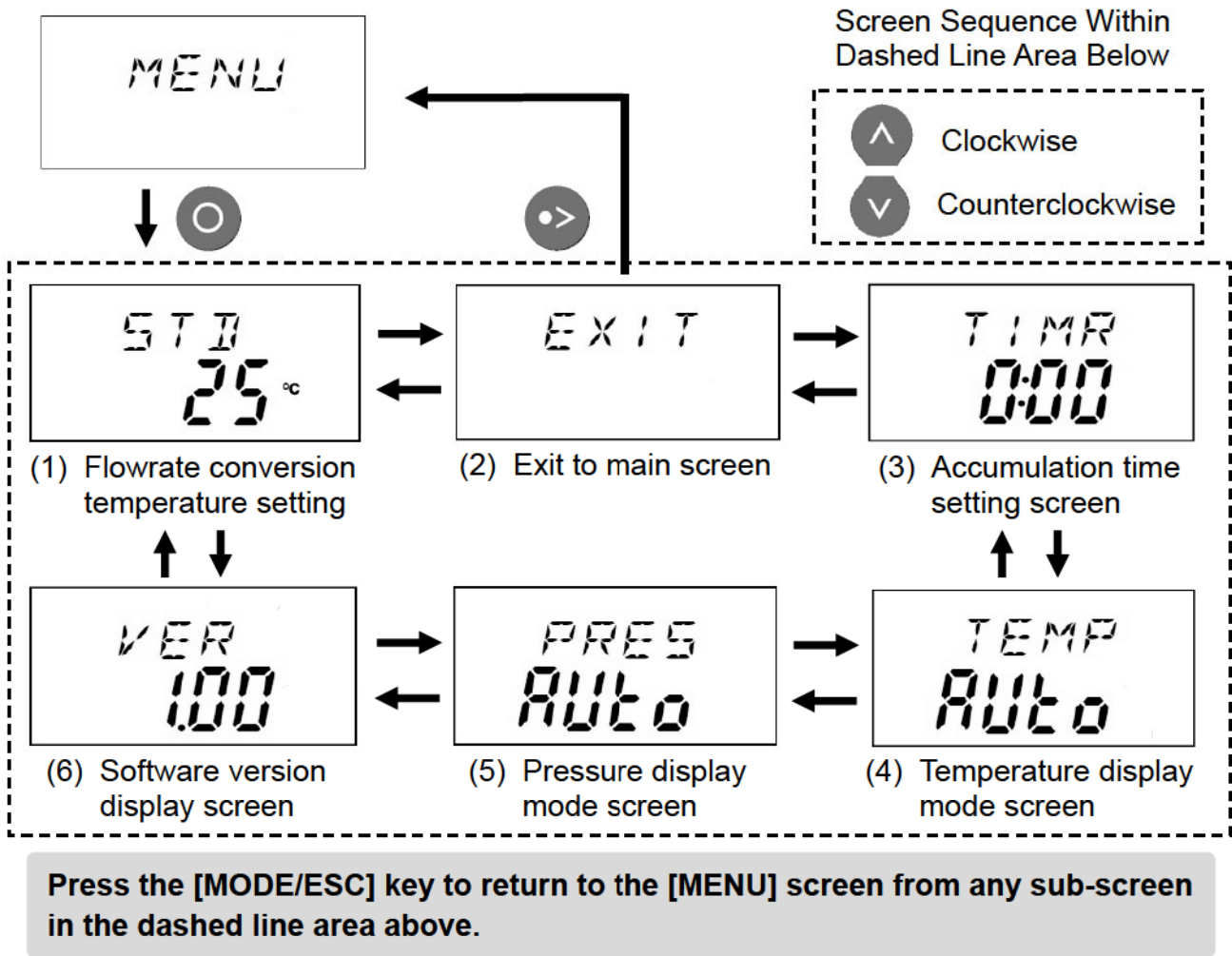

5-3 Flowrate Conversion Temperature Setting

The flowrate conversion temperature can be set as follows.

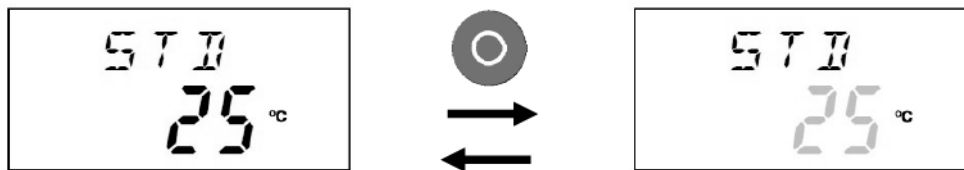

Pressing the [ENTER] key causes the numeric display to flash and enables changing the setting (default setting is 25 °C at 1 atm).

25 °C → Converts flowrate based on 25 °C at 1 atmosphere

20 °C → Converts flowrate based on 20 °C at 1 atmosphere

0 °C → Converts flowrate based on 0 °C at 1 atmosphere ACT → Actual flowrate

Select the setting using the [UP/SPAN] and [DOWN/ZERO] keys, then press the [ENTER] key to confirm the setting. Once confirmed, settings are remembered even if the power is switched OFF.

The setting can also be changed by pressing the [ENTER] key when the power is switched ON (see page 12).

5-4 Accumulation Time Setting

The accumulation time setting can be configured.

0 : 00 (No time setting configured) → Manual setting (default setting)
 _ : _ (Time setting configured) → Timer setting

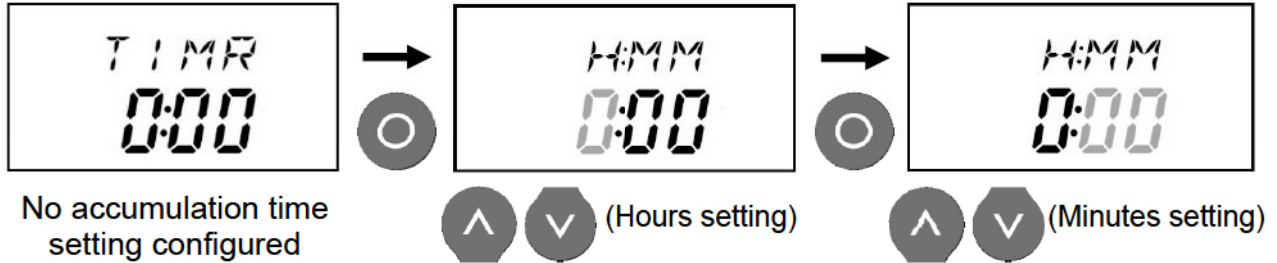

Press the [ENTER] key, which causes the hours display (hours) to flash. Then use the [UP] or [DOWN] key to set the time (hours). Once again, press the [ENTER] key, which causes the minutes display (minutes) to flash. Then use the [UP] or [DOWN] key to change the setting for minutes. Press the [ENTER] key to confirm the setting. (To return to the previous screen without changing the setting, press the [MODE/ESC] key.)

Note: The accumulation time can be configured between 1 minute and 9 hours 59 minutes.

5-5 Temperature Display Mode Setting

The temperature used to convert flowrates can also be set manually (default setting is [AUTO]).

It is recommended that this setting be used only if there is a temperature sensor problem. The setting reverts to [AUTO] when the power is switched OFF.

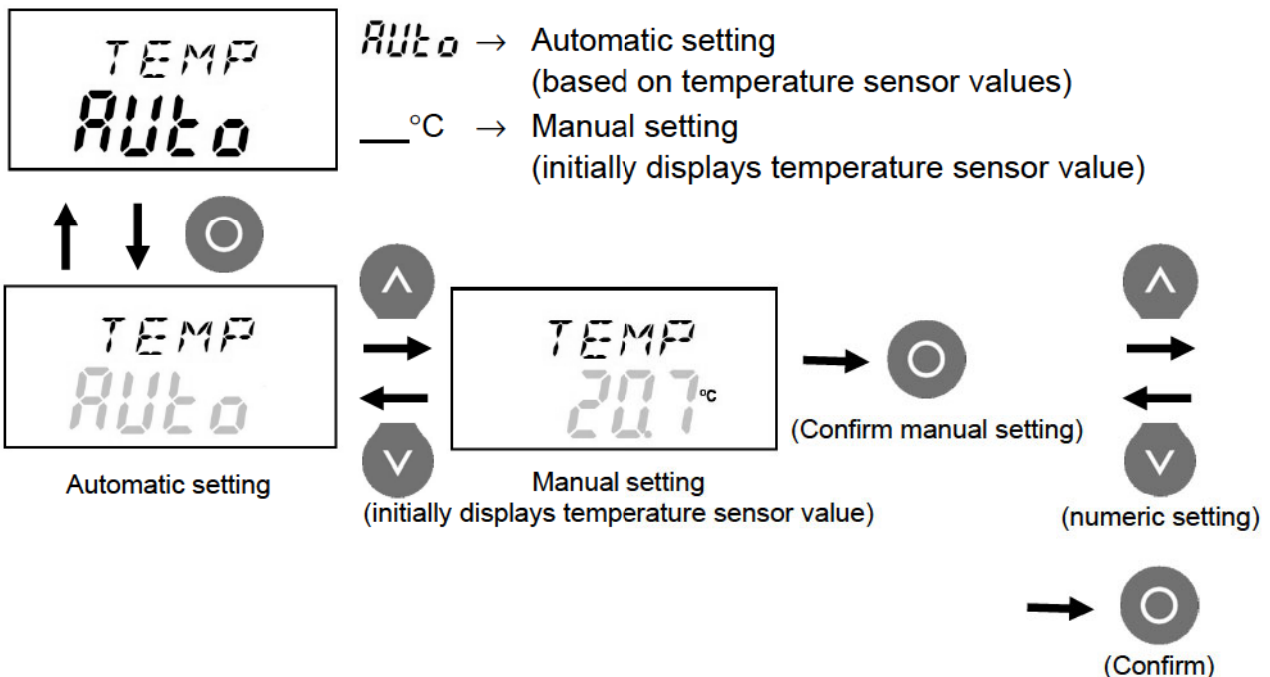

Press the [ENTER] key, which causes the display to flash, then use the [UP] or [DOWN] key to select auto or manual mode. In the manual mode, press the [ENTER] key again and then the [UP] or [DOWN] key to change the temperature value. Press the [ENTER] key to confirm the setting. (To return to the previous screen without changing the setting, press the [MODE/ESC] key.)

5-6 Pressure Display Mode Setting

The reference pressure (absolute pressure) value used to convert flowrates can also be set manually (default setting is [AUTO]).

It is recommended that this setting be used only if there is a pressure sensor problem. The setting reverts to [AUTO] when the power is switched OFF.

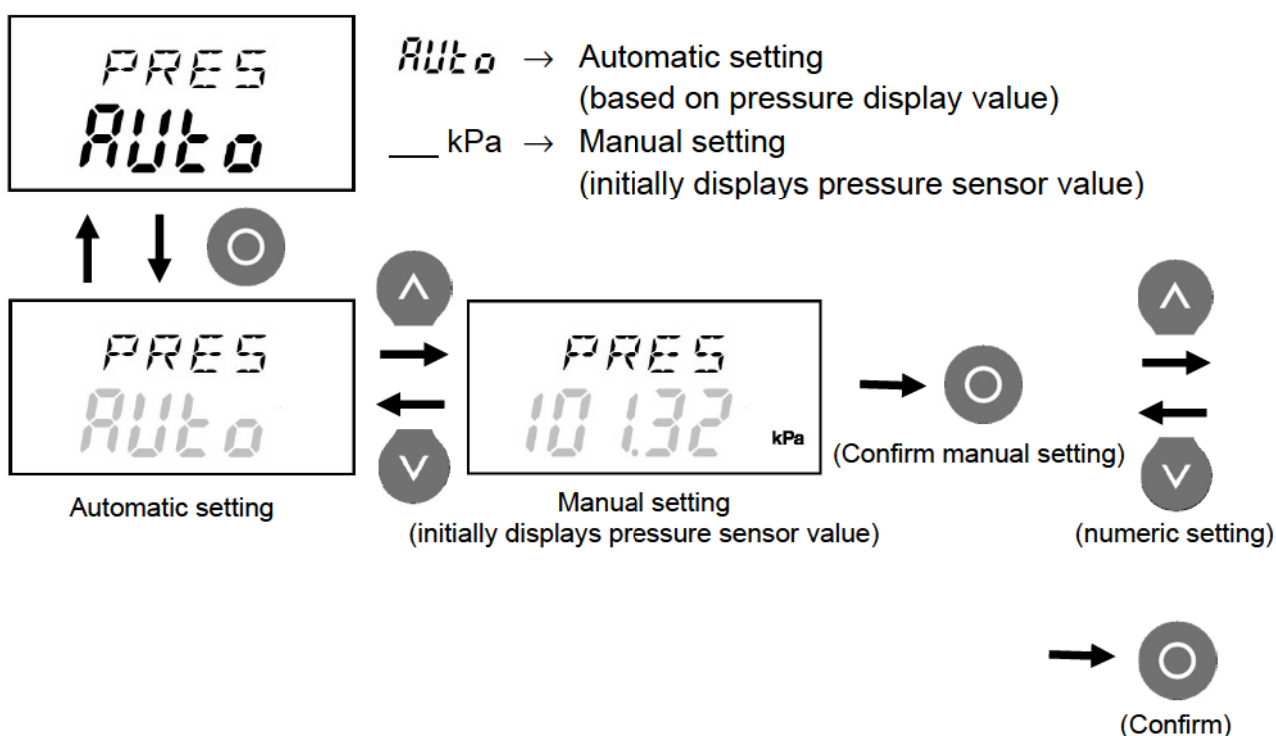

Press the [ENTER] key, which causes the display to flash, then use the [UP] or [DOWN] key to select auto or manual mode. In the manual mode, press the [ENTER] key again and then the [UP] or [DOWN] keys to change the pressure value. Press the [ENTER] key to confirm the setting. (To return to the previous screen without changing the setting, press the [MODE/ESC] key.)

5-7 Displaying the Software Version

The software version is displayed as shown to the right
(Version 1.00 in the example shown).



5-8 Returning from a [MENU] Sub-Screen to the Main Screen

- (1) In the [EXIT] screen, press the [ENTER] or [MODE/ESC] key.

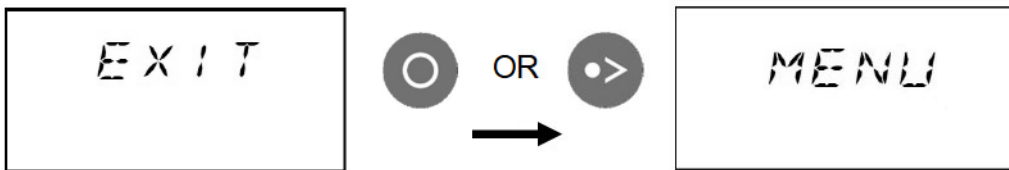

- (2) In the [MENU] screen, press the [MODE/ESC] key.



6 Calibration

LCD Screen Status



6-1 Calibrating the Pressure Sensor

The pressure sensor display value can be calibrated as follows.

- (1) With a main screen displayed, press the [MODE/ESC] key to display the pressure, temperature, or flowrate. Then hold the [CAL] key down for two seconds to illuminate the [CAL] indicator on the mode bar.



- (2) Press the [SPAN] key to illuminate the [SPN] indicator on the mode bar.
- (3) Use the [UP] or [DOWN] key to set the value back to 10000 and then press the [ENTER] key.

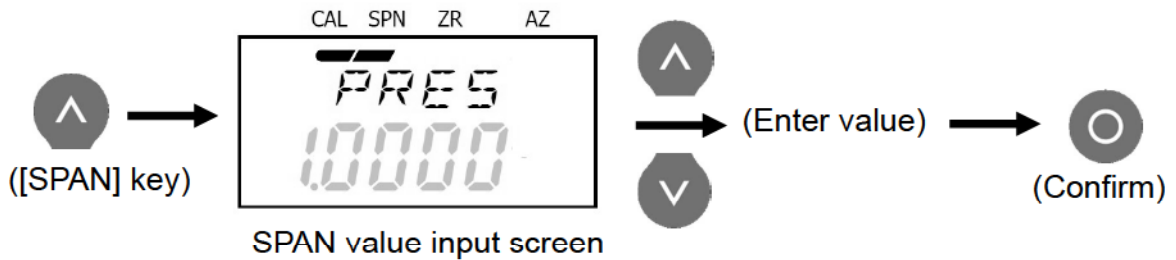

- (4) Press the [ZERO] key to illuminate the [ZR] indicator on the mode bar.
- (5) Use the [UP] or [DOWN] key to set the value back to 000 and then press the [ENTER] key.

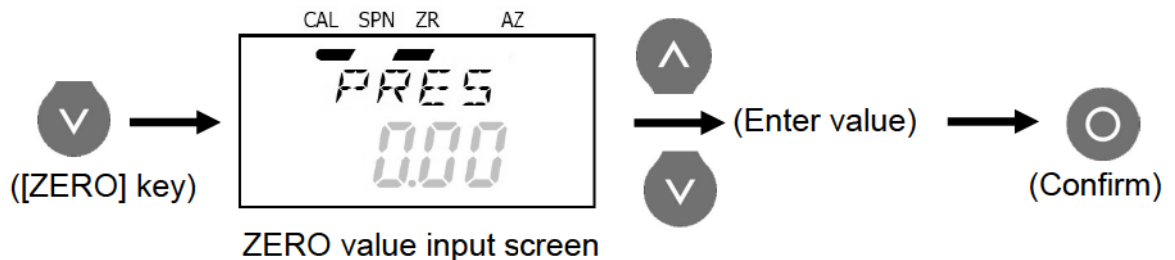

- (6) Determine the SPAN and ZERO values based on the reference pressure value and the value displayed on the LCD screen.

(→ Calculated based on the value on the reference device and the value displayed when [CAL] is indicated on the mode bar. For information about how values are calculated, see page 21.)

- (7) Press the [SPAN] key and then press the [UP] or [DOWN] key to enter the SPAN value. Then press the [ENTER] key.



- (8) Press the [ZERO] key and then press the [UP] or [DOWN] key to enter the ZERO value. Then press the [ENTER] key.
- (9) Press the [CAL] key to return to the main screen.

6-2 Calibrating the Temperature Sensor

The indicated temperature sensor value can be calibrated in the same manner as the pressure sensor value, as follows.

- (1) With a main screen displayed, press the [MODE/ESC] key to display the pressure or temperature. Then hold the [CAL] key down for two seconds to illuminate the [CAL] indicator on the mode bar.
- (2) Press the [MODE/ESC] key to display the temperature.



- (3) Press the [SPAN] key to illuminate the [SPN] indicator on the mode bar.
- (4) Use the [UP] or [DOWN] key to set the value back to **10000** and then press the [ENTER] key.

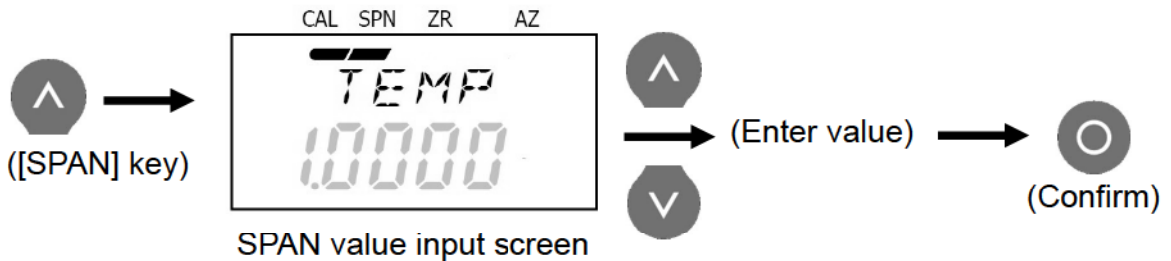

- (5) Press the [ZERO] key to illuminate the [ZR] indicator on the mode bar.
- (6) Use the [UP] or [DOWN] key to set the value back to **00** and then press the [ENTER] key.

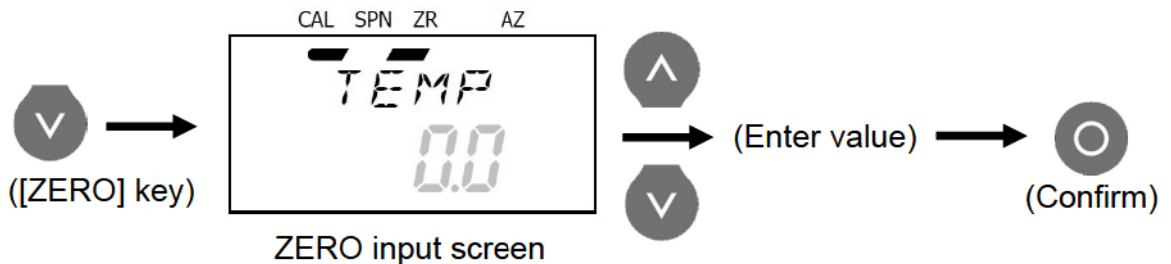

- (7) Determine the SPAN and ZERO values based on the reference temperature value and the value displayed on the LCD screen.

(→ Calculated based on the value on the reference device and the value displayed when [CAL] is indicated on the mode bar. For information about how values are calculated, see page 21.)



- (8) Press the [SPAN] key and then press the [UP] or [DOWN] key to enter the SPAN value. Then press the [ENTER] key.
- (9) Press the [ZERO] key and then press the [UP] or [DOWN] key to enter the ZERO value. Then press the [ENTER] key.
- (10) Press the [CAL] key to return to the main screen.

6-3 Determining SPAN and ZERO Values by Calibration

The SPAN and ZERO values are determined using the following formulas.

$$\text{SPAN} = \frac{\text{Reference Measurement Value}}{\text{Display Value}} \quad \text{OR} \quad \text{ZERO} = \text{Reference Measurement Value} - \text{Display Value}$$

To calibrate the values based on a constantly changing value, such as temperature or atmospheric pressure, change the ZERO value.

It is recommended to calibrate values by changing either the SPAN or ZERO value.

6-4 Accumulated and Average Flowrate Display

During flowrate measurements, average flowrate and accumulated flowrate can be displayed for a given time interval (max. 9 hours 59 minutes).

This feature is especially useful for calculating flowrate values during manual calibration of mini pump MP-ΣNII Series and MP-W5P.

- (1) Press the [Enter] key during a measurement (displays the [TIMER] indicator).
- (2) Press the [ENTER] key again (the  indicator disappears).
- (3) With the manual setting, the accumulated flowrate and average flowrate are displayed for the period between the first and second time the [ENTER] key was pressed. With the timer setting, press the [ENTER] key to activate the timer. The accumulated flowrate and average flowrate will be displayed when the set time has elapsed or the [ENTER] key is pressed once again.

Note: While the accumulated flowrate is being measured, if the timer set time is min. 1 hour, "Hours" and "Minutes" will be displayed. If it is less than 1 hour, "Minutes" and "Seconds" will be displayed.

- (4) Press the [ENTER] key to display the instantaneous flowrate again.

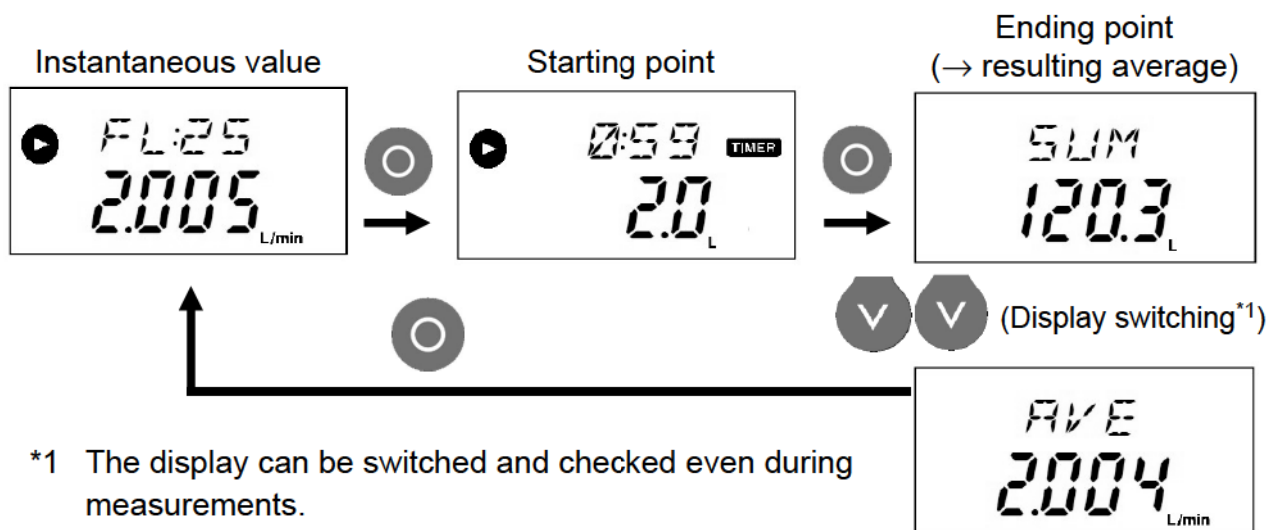

*1 The display can be switched and checked even during measurements.

6-5 Automatic Calibration

This product can be used to automatically calibrate Sibata mini pumps by preparing a set of two types of communication cables for MP-W5P/MP-ΣNII.

For MP-W5P mini pumps, a dedicated communication cable is required, but MP-ΣNII series mini pumps can also be automatically calibrated using a commercial A-mini B USB cable.

Note that automatic calibration might increase the error factor of flowrates at points not being calibrated.

For flowrate calibration, connect the components actually used, such as the collection tube, in front of the pump to increase the flowrate precision level.

6-5-1 Preparation for Automatic Calibration

Using the communication cable to connect the flow calibrator to a mini pump displays the auto-calibration screen on the flow calibrator.

Items to Prepare

- Vinyl tubing, 7mm I.D. × 10mm O.D. (Included)
- A set of two types of communication cables for MP-W5P/MP-ΣNII (Sold separately)
 - MP-W5P: Dedicated MP-W5P communication cable
 - MP-ΣNII Series: USB cable A-mini B
- FC-M1 flow calibrator
- Mini pump MP-W5P or MP-ΣNII Series
- Buffer tank (Sold separately)

The following describes the procedure for the MP-W5P.

- (1) Switch the power ON for the mini pump.
- (2) Switch the power ON for the FC-M1 flow calibrator. Warm up the FC-M1 unit by operating it for at least 10 minutes and then press the [A.ZERO] key.
- (3) Connect the dedicated MP-W5P communication cable to the MP-W5P unit first and then to the FC-M1 unit.

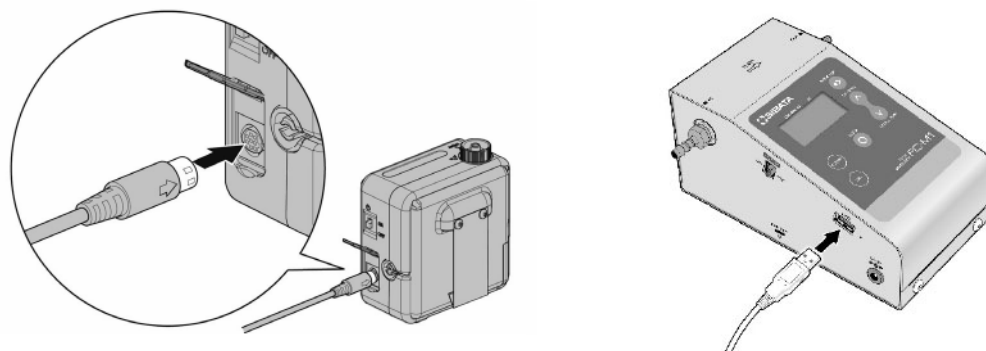

This changes the "COMM" on the flow calibrator LCD screen to "CAL" and causes the flowrate to flash.

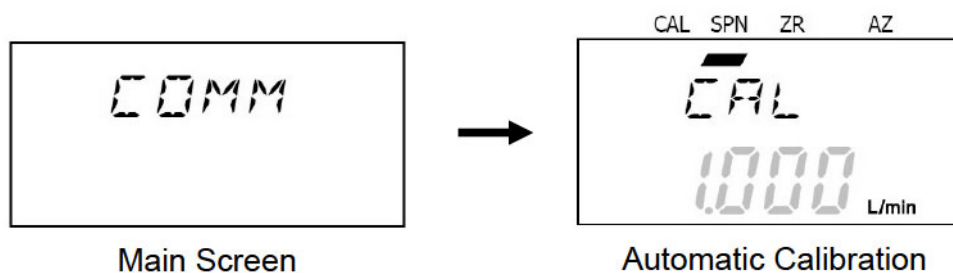

For the MP-W5P model, if no key has been operated for 30 seconds or more, the pump enters a sleep mode that prevents communication. If that occurs, press any key except the [START/STOP] key on the MP-W5P unit before pressing the [ENTER] key on the FC-M1 unit.

- (4) Connect tubing between the buffer tank and the exhaust port on the FC-M1 flow calibrator and between the buffer tank and the air intake port on the mini pump.

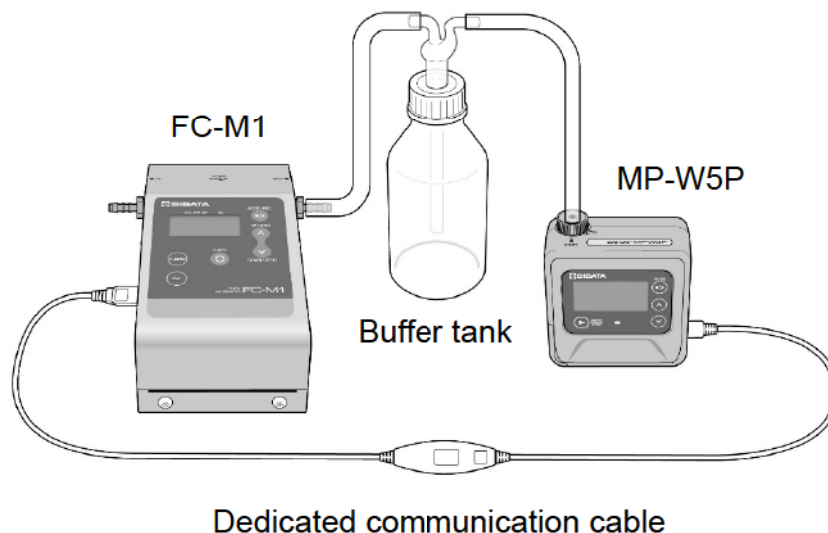
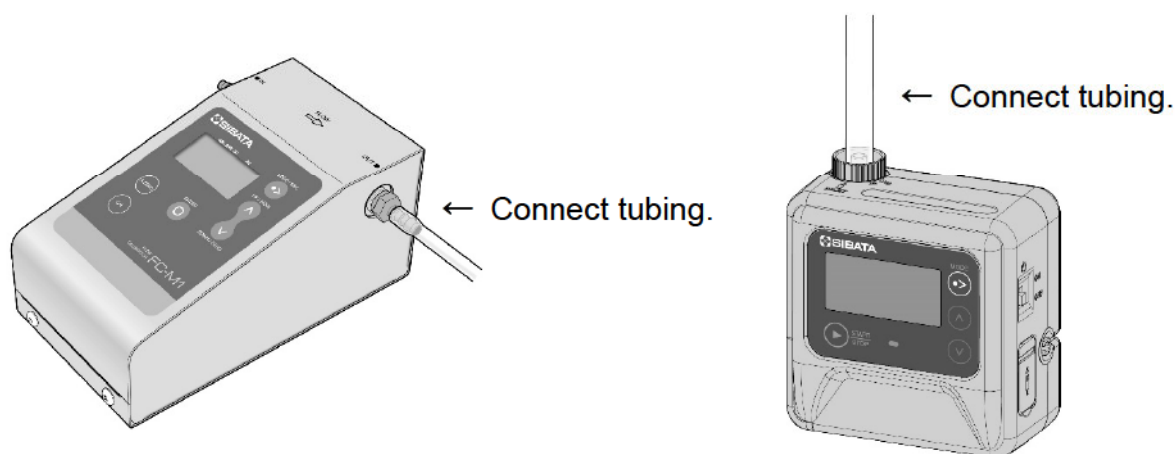

Using an MP-W5P Mini Pump to Measure Low Flowrates (0.200 L/min or less)

If the collection tube actually used is not available when using the FC-M1 flow calibrator to verify the MP-W5P mini pump flowrate, calibrate the flowrate by connecting the low-flowrate orifice adapter included with the product in front of the MP-W5P mini pump (as shown below).

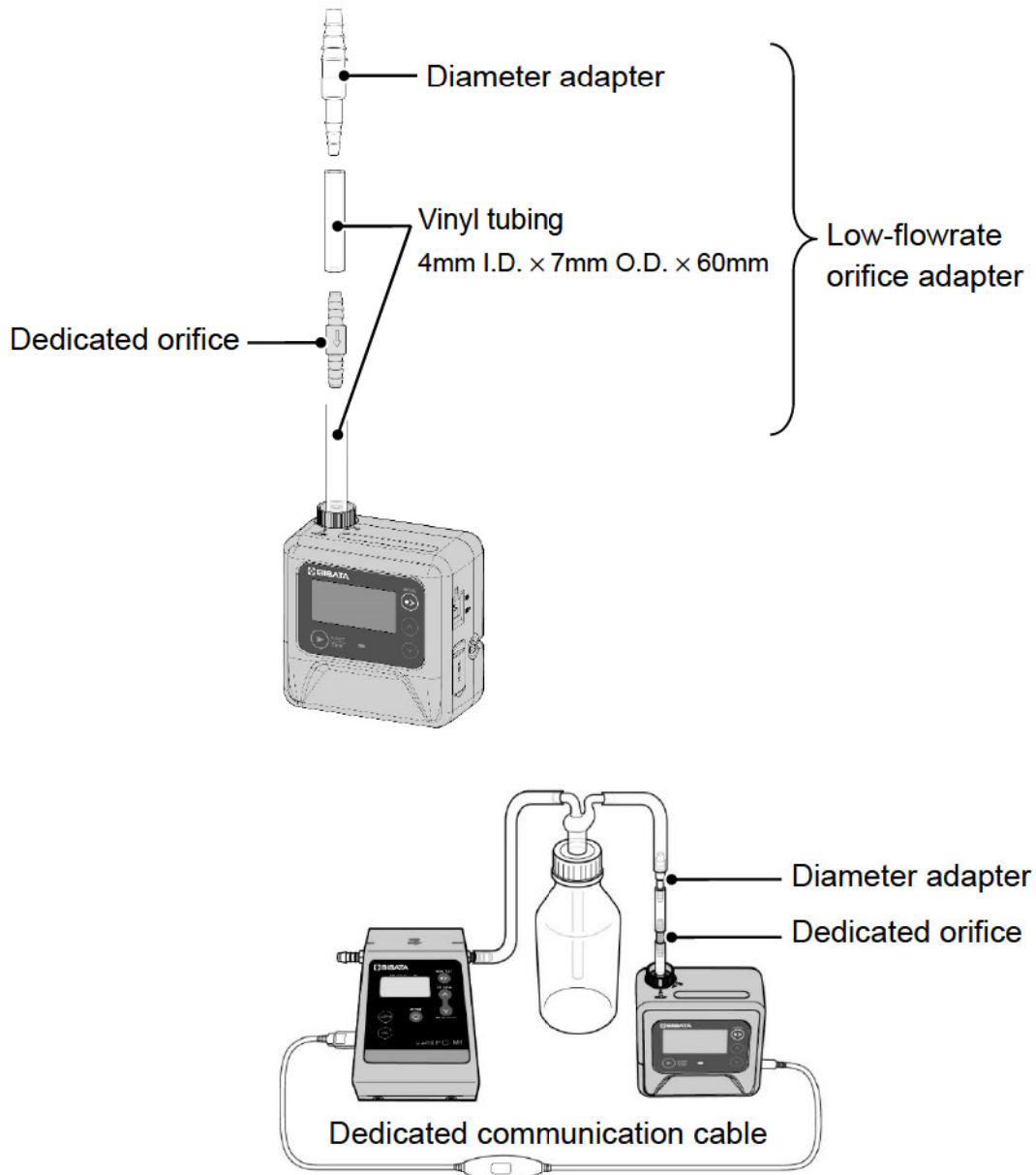

Using an MP-ΣNII Series Mini Pump

The operating procedure is basically the same as for the MP-W5P, except for the following points.

- Use an A-mini B type USB communication cable.
- For MP-Σ30NII mini pumps, use the ultra low flowrate suction holder included with the pump to calibrate flowrates of 0.150 L/min or less.
- For MP-Σ100HNII mini pumps, apply an appropriate load during calibration.

6-5-2 How to Perform Calibration Automatically

Calibrate flowrate with the collection tube to be used connected to the pump.

All operations are performed on the FC-M1 flow calibrator unit.

- (1) Select the flowrate to calibrate using the [UP] and [DOWN] keys on the FC-M1 flow calibrator. Then press the [ENTER] key to confirm the setting.
- (2) Press the [ENTER] key again to start calibrating the flowrate (calibration takes about 2 minutes).

If an MP-W5P pump is being used, a blue indicator will flash to indicate the pump is running.

If an MP-ΣNII series pump is being used, a green indicator will flash to indicate the pump is running.

(Provided the respective indicators are set up to illuminate)

Note: To cancel the calibration, press the [MODE/ESC] key.

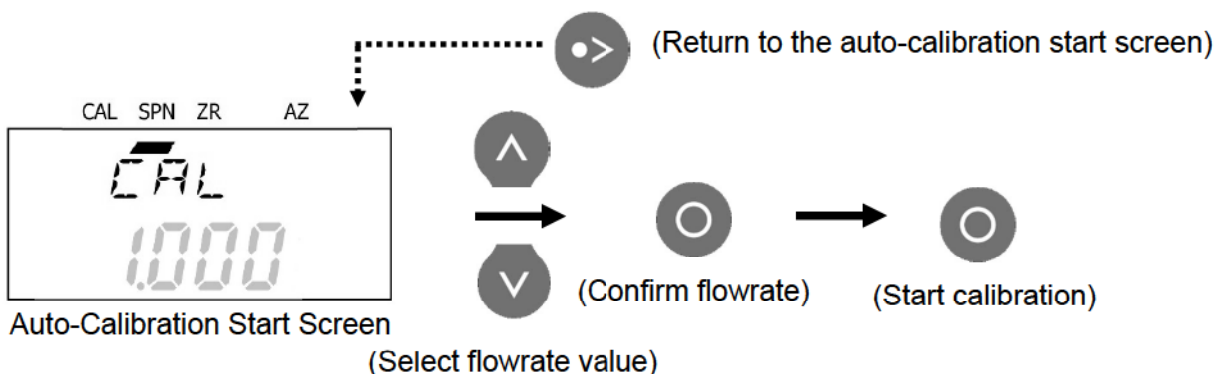

- (3) After calibration, a [PASS] indicator is displayed in the flowrate display area if automatic calibration was successful. Press the [MODE/ESC] key to return to the auto-calibration start screen.

On the MP-W5P pump, [FLOW] is displayed again (on the flowrate setting screen).

On MP-ΣNII series pumps, [TOT] (accumulated flowrate) is displayed (and the indicator illuminates orange).

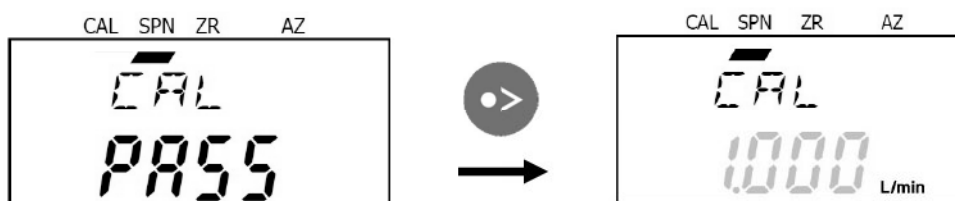

- (4) The main screen is displayed again when the dedicated communication cable or USB cable is disconnected.

All MP-W5P keys are disabled during automatic calibration. If a USB error occurs during automatic calibration, MP-W5P pumps cannot be stopped using key operations. In that case, force it to stop by switching the power switch OFF on the MP-W5P mini pump.

If automatic calibration fails, the screen shown to the right is displayed.

If this screen appears, check the following and try the operation again.

- The dedicated communication cable or USB cable is connected.
- Power to the mini pump was not disrupted during automatic calibration.



Automatic calibration is canceled even if power is restored after a power interruption.

A USB error will occur if the dedicated communication cable or USB cable is disconnected during automatic calibration.

If the power supply to the mini pump is interrupted during automatic calibration, start over from step (1) in 6-5-1 Preparation for Automatic Calibration.



FC-M1 screen after power supply was interrupted to the mini pump during automatic calibration.

For the MP-W5P model, if no pump operations are performed for 30 seconds or more during automatic calibration, the pump enters a sleep mode that prevents communication. If that occurs, press any key except the [START/STOP] key on the MP-W5P unit to switch from the sleep mode to the normal mode and enable communication again.

7 Storage

- Always store the FC-M1 flow calibrator with the rubber feet oriented downward.
- Store the unit within a temperature range of 0 to 40 °C and humidity range of 10 to 90 % RH.
- If the unit will not be used for an extended period, remove the batteries.

8 Maintenance

To maximize the product service life, perform periodic inspections.

Clean the unit by wiping it with a tightly wrung rag or a dry cloth. To remove significant dirt or contamination, wipe with dilute ethanol.

Note: The AC adapter (optional) is not protected against liquids, so do not clean it in this manner.

In the following cases, repair or inspection by the manufacturer is required. Contact your Sibata representative or the distributor where you purchased the product.

- **Over one year has elapsed since the flowrate was calibrated by Sibata.**
- **Rubber parts have started hardening or cracking.**

In addition, if any other malfunction or problem occurs, contact your Sibata representative or the distributor where you purchased the product.

9 Troubleshooting



Before sending the product in for repairs, inspect it one more time. If it still does not function properly, contact your Sibata representative or the distributor where you purchased the product.

Symptom	Possible Cause	Remedy
Nothing is displayed or what was displayed has disappeared.	Batteries are depleted.	Replace with them new batteries.
	Batteries are not installed properly.	Reinstall batteries in the correct orientation.
	The AC adapter (optional) is unplugged.	Plug in the AC adapter.
Indicated temperature or pressure sensor values are clearly incorrect.	Temperature sensor or atmospheric pressure sensor has failed.	The unit must be repaired. Contact your Sibata representative or the distributor where you purchased the product. The temperature and atmospheric pressure values can also be set manually (see pages 16 and 17).

Continued on the next page

Symptom	Possible Cause	Remedy
The indicated flowrate value is clearly incorrect.	The unit is not airtight.	Make sure flow lines are connected properly. If the problem persists, request inspection and repairs.
	The sensor has failed.	The unit must be repaired. Contact your Sibata representative or the distributor where you purchased the product.
Cannot exit the COMM mode.	The dedicated communication cable or USB cable is still connected.	Disconnect the dedicated communication cable or USB cable.
Communication is not possible even after connecting the dedicated communication cable to the mini pump.	The mini pump is in the sleep mode.	Press any key except the [START/STOP] key on the mini pump.

10 Summary of Error Screens

Error Name and Display	Status	Remedy
 <p>Over Mark Display</p>	Indicates the accumulated flowrate display range has been exceeded.	Use a range that does not exceed the display range.
 <p>USB Error</p>	Indicates a communication error occurred.	Press the [MODE/ESC] key or restart the FC-M1. Then connect the dedicated communication cable or USB cable.
 <p>Auto-Calibration Failure Error</p>	Indicates automatic calibration failed.	

11 Specifications

Item Code	080120-158
Model	FC-M1
Flowrate Display Range	0 to 6 L/min
Guaranteed Flowrate Precision Range	0.050 to 5.000 L/min ^{*1}
Flowrate Precision	Within ± 2 % or ± 0.003 L/min of the measured flowrate, whichever is greater ^{*2}
Flowrate Detection Method	Differential pressure detection
Operating Temperature and Humidity Range	0 to 40 °C, 10 to 90 %RH
Dimensions	W105 × D170 × H100 mm (excluding protrusions)
Weight	Approx. 0.9 kg (including batteries)
Power Supply	5 V DC (four AA alkaline batteries)
Battery Life	Min. 8 hours ^{*3}
Parts Included	Four AA batteries (for confirming functionality) Vinyl tubing, 7 mm I.D. × 10 mm O.D. × 2.5 m Low-flowrate orifice adapter × 1 (Vinyl tubing, 4 mm I.D. × 7 mm O.D. × 60 mm 2 pcs., dedicated orifice and diameter adapter)

*1 Actual measured or converted flowrates can be displayed. Flowrate can be converted in terms of 25 °C at 1 atm, 20 °C at 1 atm, and 0 °C at 1 atm.

The specified precision may not be achieved when operated at a site with a large difference between high and low temperatures.

*2 The specified precision may not be achieved when operated at temperatures below 10 °C, 30 °C or higher, or in environments with sudden temperature changes.

Note that the flowrate precision is with respect to the instantaneous value. Treat the accumulated flowrate value as a reference value.

*3 Approximation based on continuous operation using AA alkaline batteries at 25 °C.

■ Items Sold Separately

Item Code	Product Name	Remarks
080860-59	A set of two types of communication cables for MP-W5P/MP-ΣNII	Required for automatic calibration on MP-ΣNII series or MP-W5P mini pumps.
080880-1000	Buffer tank	Required for calibrating flowrate on MP-ΣNII series or MP-W5P mini pumps.

■ Options

Please purchase these separately, based on intended applications.

Item Code	Product Name
080120-1511	Soft case for FC-M1
080120-1571	AC adapter, SMI18-5-V-P5

12 Warranty and Repairs

If a Sibata product fails within one year from date of purchase, it will be repaired free of charge. To request repairs, contact the distributor where you purchased the product. Consumables (rubber parts) included with Sibata products are not covered by the warranty. The warranty excludes any problems resulting from any of the following causes. Such repairs are subject to normal service fees.

- Faults or damage due to improper usage
- Faults or damage resulting from repairs or modifications implemented by parties other than Sibata
- Faults or damage resulting from fires, earthquakes, or other natural disasters
- Faults or damage resulting from salt damage, gas damage, or abnormal voltage
- Faults or damage occurring after purchase due to relocation, movement, falling, or vibration
- Faults or damage resulting from the use of consumable items not specified by Sibata
- Any case in which the date of purchase or a signature has not been provided on the warranty by the distributor where you purchased the product, or the warranty items have been altered
- [Modifications and Repairs Are Prohibited] Never disassemble or modify this product, as doing so will void the warranty with Sibata. Doing so may also result in an unforeseen fault and accident.

For more information regarding repairs after the warranty period, contact the distributor where you purchased the product. If Sibata determines that repairs can restore normal performance levels and that those levels can be maintained as long as the specified operating methods are used, then Sibata offers repair services on a fee basis. When shipping the product to Sibata for repairs, fill out a Problem Report Form and include it with the shipment (see page 31).

13 Product Disposal

Dispose of the product in accordance with all local laws and regulations. The main unit is mostly made of aluminum and plastic (POM).

14 Inquiries

If you have any questions about this product, or if there is any other way in which we can be of assistance, contact the distributor where you purchased the product or your Sibata representative.

Problem Report Form

The Problem Report Form is for users to provide the information necessary to ensure that the process of inspecting and repairing the problem can be performed smoothly. Please complete the form in as much detail as possible. Please also include this Problem Report Form with your shipment when requesting repairs.

FC-M1 Flow Calibrator Problem Report Form

If a problem occurs, please copy and fill out this Problem Report Form and contact your Sibata representative or the distributor where you purchased the product.

Date completed: _____(yyyy/ mm/dd)

Circumstances Under Which the Product is Used

Model: FC-M1 Purchase date: _____(yyyy/ mm/dd)

Serial No.: _____

Software version: _____

Date of first use: _____(yyyy/mm/dd)

Frequency of use: : Daily : _____ days a week : _____ days a month

Hours of use per day: _____

Temperature of operating environment (actual measurements, if possible):

Between _____ and _____ °C

Number of units owned: _____ Used for: _____

Model number of connected mini pump: MP- _____

Problem Description

Frequency of occurrence: : Daily : Occasionally : Rarely : Other
(For "Other," explain: _____)

Timing of occurrence: : Immediately after purchase : Within 1 month
: Within 1 week
: Other (_____)

Symptoms (in as much detail and as specifically as possible):

Example: No flowrate is displayed, even when the pump is pumping air through the unit.

Check List (circle all applicable)

- Is anything displayed on the screen when the unit is switched ON? (Yes / No)
- Is the unit rusty, corroded, or dirty? (Yes / Not very much)
- Is the unit being used in an environment containing significant levels of chemicals? (Yes / No)
- Does the unit show any signs of being dropped or impacted? (Yes / No)

Check List for Requesting Repairs

- : Fill out a copy of the Problem Report Form and include it inside the shipping box.
- : If the intake of a hazardous substance is possible, place this form in an envelope and affix it to the shipping box exterior. Please make a note of that accordingly.



DISTRIBUTED BY:

Sedulitas

PEOPLE | PASSION | PRECISION

info@sedulitas.co.za +27 (0)82 551 4001

www.sedulitas.co.za

SIBATA SCIENTIFIC TECHNOLOGY LTD.



1-1-62, Nakane, Soka, Saitama, 340-0005, Japan

TEL:+81-48-933-1582 FAX:+81-48-933-1591

E-mail:overseas@sibata.co.jp

<http://www.sibata.co.jp/english/>

Note) Shape, dimensions, specifications, and other product information are subject to change without notice in the interest of product improvement to the extent that product functions and applications will not be impaired.