

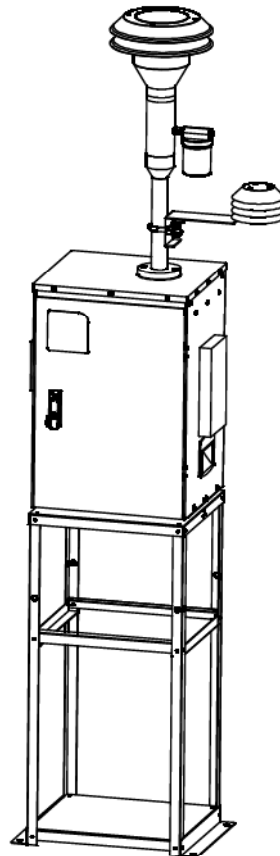

PM2.5 Sampler LV-250R

OPERATION MANUAL



Thank you for purchasing this product.

- This operation manual describes precautions that are important for preventing accidents as well as the procedures used to handle the product.
- To ensure safety, read this operation manual and the attached warranty thoroughly before use, and use the product correctly.
- After reading this operation manual and the warranty, keep them in a safe place where they can be referred to at any time.

Contents

Before Use	1
Safety Precautions	2
Product Overview	5
Features	5
Names of Parts	6
Main Unit	6
Main Unit Interior	7
Control Panel	8
Instructions for Use	9
Installation Procedure	9
Wiring Procedure	10
Installing and Cleaning the PM10 Impactor	11
Removing the Filter holder support and PM2.5 Impactor	14
Replacing the PM2.5 Impactor	15
Replacing the Filter Holder	16
Attaching the Filter holder support and PM2.5 Impactor	17
Plug Valve	18
Airtight Test	18
How to Operate the Control Panel	19
How to View the LCD	20
Sampling Method (Basic Operations)	21
Suction Flow Rate Setting	21
Timer Selection	22
Sampling Start Time Setting (ON Timer)	23
Sampling Stop Time Setting (OFF Timer)	24
Starting Sampling	25
Operation Methods	26
Overview of Screen Display	26
Before Sampling	28
Sampling Start Standby	43
During Sampling	44
After Sampling is Stopped	48
Power Failure Processing	50
Fault Stop Function	52
Maintenance	53
Troubleshooting	54
Main Specifications	55
Options and Consumables	56
Warranty and Repair	57
Disposal of the Product	58
Inquiries	58
Trouble Notification Sheet	59

Before Use

 WARNING	<ul style="list-style-type: none">● Be sure to read this operation manual thoroughly before using the product, and be sure to use the product correctly.● Keep this operation manual in a safe place where it can be referred to at any time.● Be sure to familiarize yourself with and observe the safety precautions given in this operation manual.● Observe usage procedures that are suitable for the product and that are specified in this operation manual. <p>Be sure to observe the above instructions. Not following these instructions may result in an accident or injury.</p>
--	--

■ About This Operation Manual

- In the interests of product improvement, the contents of this operation manual may be changed without notice.
- Every effort has been made to ensure that the information contained in this operation manual is correct. If you discover any errors or omissions, however, please contact your Sibata representative.
- The copyright of this operation manual belongs to Sibata Scientific Technology Ltd. The reproduction of all or part of this operation manual without prior written permission from Sibata Scientific Technology Ltd. is prohibited.

■ Checking the Package

Check the contents of the package before using the product.

- **PM2.5 Sampler unit** 1
- **Filter holder** 1
- **PM10 Impactor** 1
- **PM2.5 Impactor** 1
- **Spare fuse 2A** 1
- **Operation manual (this document)** 1

Safety Precautions

The precautionary information that appears in this operation manual is for ensuring that the product is used safely and for preventing injury to you and other people and damage to equipment. It is all important for ensuring safety and so be sure to read it thoroughly before using the product and observe it during use.

■ Users (Important)



This product must be operated only by persons with adequate specialist skills, training, and experience to understand the potential dangers of operating the product. Persons who are untrained or still undergoing training may operate the product only under guidance from a trained person or a person with specialized experience.

This operation manual was written on the assumption that the product will be operated only by users who fully understand the potential dangers of operating the product.

■ Warning Labels

In this operation manual, precautionary information is labeled. The degree of damage or injury that may occur if the product is used without consideration of the corresponding item of precautionary information is indicated by one of three labels: DANGER, WARNING and CAUTION. These labels indicate precautionary information that is important for ensuring safety and so be sure to observe them.

Labels Indicating Degrees of Damage or Injury

 DANGER	Indicates a potentially hazardous situation which, if not avoided, could result in serious injury or possibly death.
 WARNING	Indicates a potentially hazardous situation which, if not avoided, could result in serious injury.
 CAUTION	Indicates a potentially hazardous situation which, if not avoided, may result in minor to moderate injury or equipment damage.

DANGER

- Do not use this product near highly flammable or potential fire hazards. Doing so might cause explosion or fire.
- No Fires Allowed! Do not put this product into fires. Doing so might cause explosion or fire.

WARNING

- Install this product on a level, stable location, and be sure to fasten it with ropes to prevent it from tipping over. Failure to do so might cause malfunction, accidents, or abnormal operation.
- This product is waterproofed but only against rainwater falling from above. Avoid direct contact with water from the side. Failure to do so might cause malfunction or fire.
- This product is designed for outdoor installation. However, it should not be used on very windy or rainy days. Such conditions could cause the product to tip over, resulting in malfunction.
- Do not subject this product to strong impact or drop it. Doing so might cause malfunction or accidents.
- Never dismantle or modify this product. Doing so might cause malfunction or accidents.
- If an abnormality occurs during operation, immediately stop operation and remove the cause of the abnormality. When the abnormality is judged to be caused by this product, turn the power switch OFF, disconnect the power plug and contact your Sibata agent. Do not use this product in an abnormal state or allow it to be dismantled for repair by non-service personnel. Doing so might cause malfunction or accidents.
- Do not run this product wrapped in a cloth or bedding, or enclosed in a box. Doing so might cause heat to build up, resulting in fire or malfunction.
- Do not connect the power adapter to a multi-plug power strip. Doing so might cause electric shock or fire.
- Do not use this product when the power cord is damaged or the plug inlet on the power outlet is loose. Use in this state might cause fire or electric shock.
- Do not touch the power cord or power outlet with wet hands. Doing so might cause electric shock.
- This product is installed outdoors. Accordingly, if an extension cord is used, ensure that it is waterproofed. Sibata assumes absolutely no responsibility for accidents resulting from extension cords.
- This product uses a Panasonic WF7515K waterproof plug (for 100 V). Using a Panasonic **WA3519K waterproof outlet** with the same rating as the inlet will ensure that the plug and outlet section is thoroughly waterproof.
- Be sure to ground this product. During the installation process, remove the power cord from the outlet. Failure to do so might cause malfunction or electric shock. Also, never attach it to a gas pipe. Doing so might cause an explosion or fire.
- Do not use a non-specified fuse. Doing so might cause malfunction or accidents.
- Do not block the exhaust and suction ports. Doing so will prevent the required airflow into the product, and cause heat to build up inside, resulting in malfunction or fire.
- Covering your head with the plastic bag that this product is packed in could cause suffocation. Never do this.

WARNING

- This product is an air sampler. Do not use the product for any purpose not described in this manual. Doing so might cause malfunction.
- Do not store this product where it will be exposed to direct sunlight, or near fire. Doing so might cause abnormal operation or malfunction.
- If this product is exposed to strong sunlight, the product may become hot. When handling it, be careful to avoid burning your hands.
- When assembling this product, be careful not to get your hands caught in the equipment, or to bump into the equipment.
- Never transport the equipment with the main unit attached to the stand. There is a risk that the twist fasteners will be damaged.
- Do not place objects on top of this product. Doing so might cause the product to tip over or deform the product, resulting in accident or malfunction.
- Before cleaning or inspecting this product, disconnect the power plug from the power outlet. Failure to do so might cause electric shock, electric leak or other abnormalities.
- Do not use chemicals to wipe down unspecified parts of this product. Also, do not use unspecified chemicals. Doing so might cause malfunction.
- The main unit can be used with a single-phase 100 V to 240 V (85 V to 264 V) power source, but the power outlet is only designed for 100 V. Contact your Sibata representative or the vendor if you will be using the equipment at a voltage outside of these specifications.
- When not using this product, disconnect the power plug from the power outlet. Failure to do so might cause fire or malfunction.
- When disconnecting the power plug, be sure to hold the power cord by the power plug. Pulling the cord might damage it and cause electric shock or fire.
- Before use, check the sheath of the power adapter cord for scratches or other abnormalities. Also, do not place heavy objects or step on the power cord. Use in an abnormal state might cause fire or electric shock.
- Do not use wires, other metallic objects, or any other connection method not specified in this manual. Doing so might cause malfunction.
- Do not allow water and other liquids, and gases other than air to be sucked in. Also, do not allow corrosive gases (e.g. salt air) or chemicals to be sucked in. Doing so might cause malfunction or fire.
- Be sure to install a backup filter in the main unit interior before operating the product. Malfunction might result from direct, long term intake of air.
- Do not insert screws or other foreign objects into the suction and exhaust ports. Doing so might cause malfunction. Should foreign objects get inside this product, immediately turn the power switch OFF, disconnect the power plug, and contact your Sibata agent.
- The operating temperature and humidity ranges of this product are 0 to 40 °C and 10 to 90 % rh (no condensation), respectively. Use of this product outside of these ranges might impair its performance and service life, resulting in malfunction.
- Do not bring this product close to equipment that generates electrical noise. Also, do not install it at locations subject to strong magnetic fields, or lots of dust or humidity. Doing so might damage the hardware, for example.
- Note that, should some nonconformity occur, Sibata does not assume any liability whatsoever for compensation of data or content that could not be acquired or logged as a result, loss of data or other content, and other direct and indirect damages relating to the preceding. Periodically back up data as a precaution against malfunction or accidents.

Product Overview

The LV-250R is a PM2.5 sampler. It is capable of mass concentration measurements of particulate matter (PM2.5) using a filter, based on the interim measurement manual designated by the Japanese Ministry of the Environment. With this sampler, airborne particulates in environmental air are sucked in at a constant flow rate via a suction port. PM2.5 particles (particulate matter with an aerodynamic diameter of 2.5 μm , and a 50 % cut) passed through an impactor are then captured on a filter. Suction flow rate changes are minimized by a constant flow rate unit equipped with temperature and ambient pressure correction features, so the sizing characteristics of the impactor are kept constant. The temperature of the filter unit is controlled so that it is always within 5 °C of the external ambient temperature. This prevents revaporization of volatile matter contained in the PM2.5 particle sample.

Features

- The constant flow rate unit keeps the suction flow rate constant, thus maintaining the sizing characteristics of the impactor.
- Automatically corrects the suction flow rate for changes in the external ambient temperature or ambient pressure.
- The suction pump provides a high suction pressure and maintains a stable suction flow rate even with increases in filter pressure loss.
- To prevent revaporization of volatile matter, the temperature of the filter unit is always controlled to within 5 °C of the external ambient temperature.
- The ON/OFF timer feature enables the user to set the sampling start time and stop time.
- Displays the flow rate, time, temperature, pressure and other measurement values.
- The measurement values (total flow rate, average flow rate, flow rate coefficient of variation, ambient pressure, pressure loss, ambient temperature, and filter temperature) are imported to a PC for display or storage. (A special communications cable and software are optionally available.)
- If a power outage causes a temporary stop, or problems with the flow rate or filter temperature occur, the time of the occurrence is recorded.
- The equipment can use across a wide voltage range, from 100 V to 240 V. If a DC power supply and cable are available, it can be battery operated.

Note: For use at anything other than 100 V AC, the DC power supply and cable must be custom-ordered, so contact your Sibata sales representative or the vendor.

Names of Parts

Main Unit

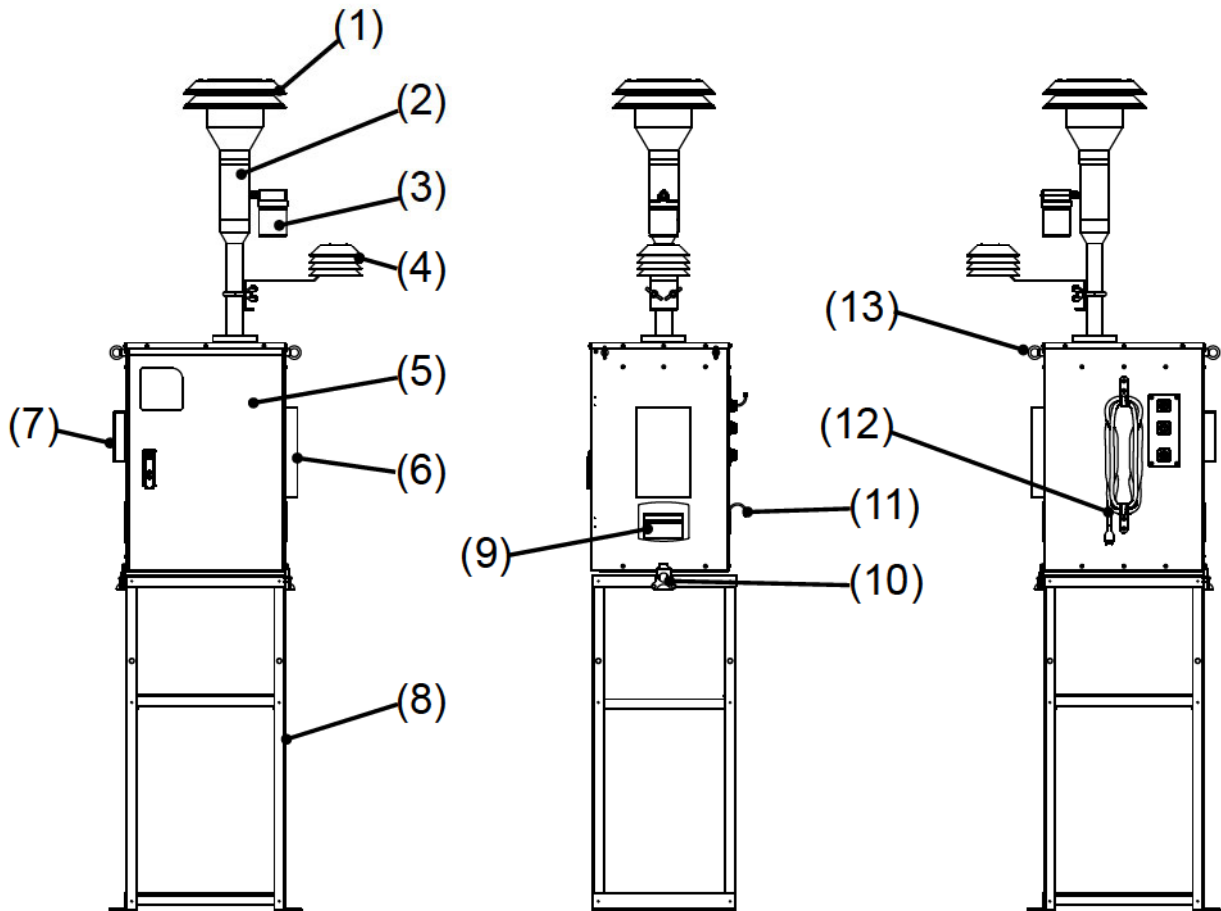

(1) Sample air inlet

(2) PM10 impactor

(3) Rainwater trap

(4) Ambient temperature sensor

(5) Door

(6) Cooling air intake port

(7) Cooling air exhaust port

(ambient pressure measurement port built in)

(8) Stand

(9) Main unit grip

(10) Twist fastener

(11) Cord stopper

(12) Power cord

(13) Eye bolt

Main Unit Interior

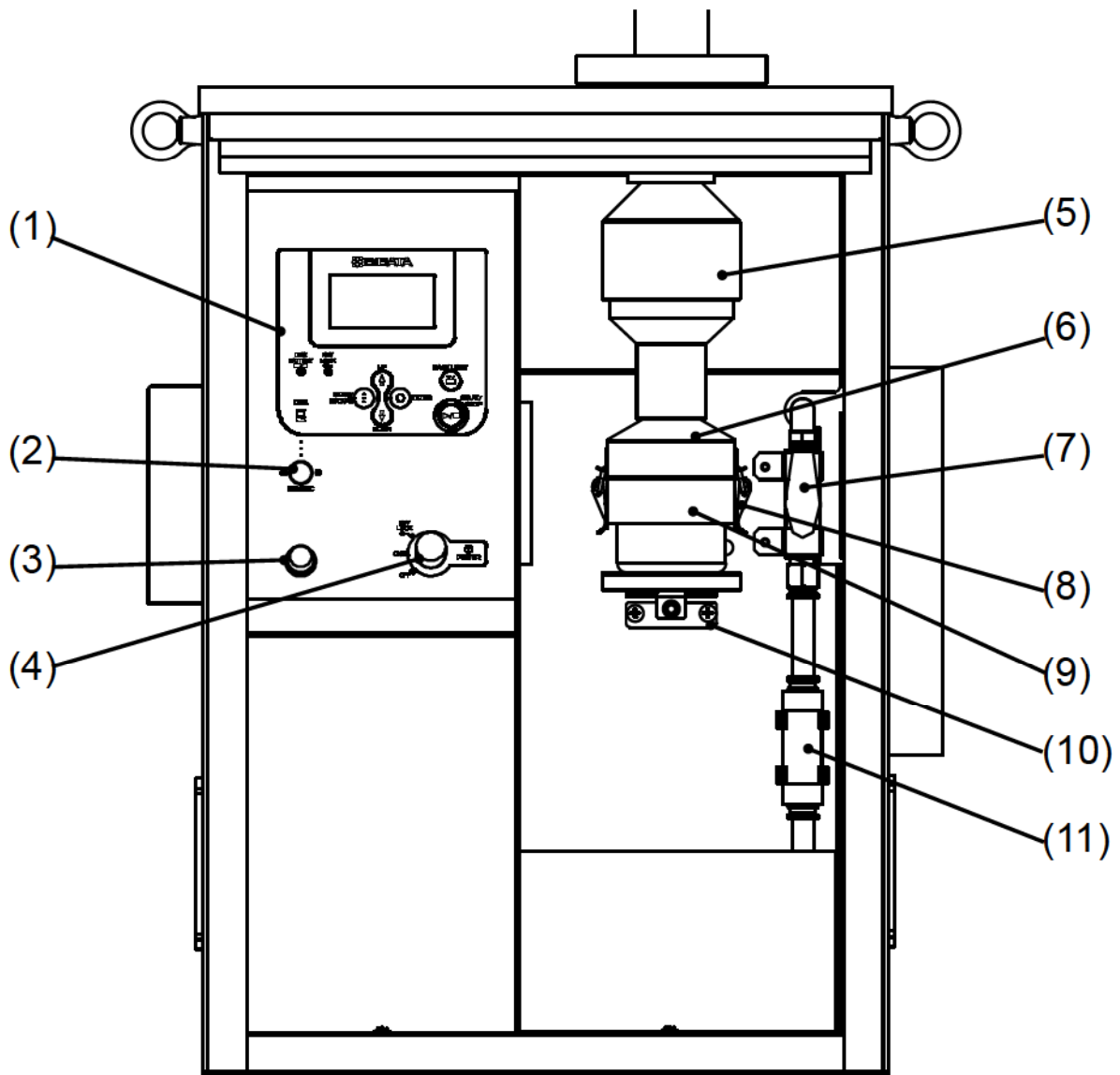

(1) Control panel

(2) RS-232C connector

(3) Fuse

(4) Power switch

(5) PM2.5 impactor

(6) Filter holder support upper section

(7) Plug valve

(8) Catch clip

(9) Filter holder support lower section

(10) Torque hinge

(11) Backup filter

Control Panel

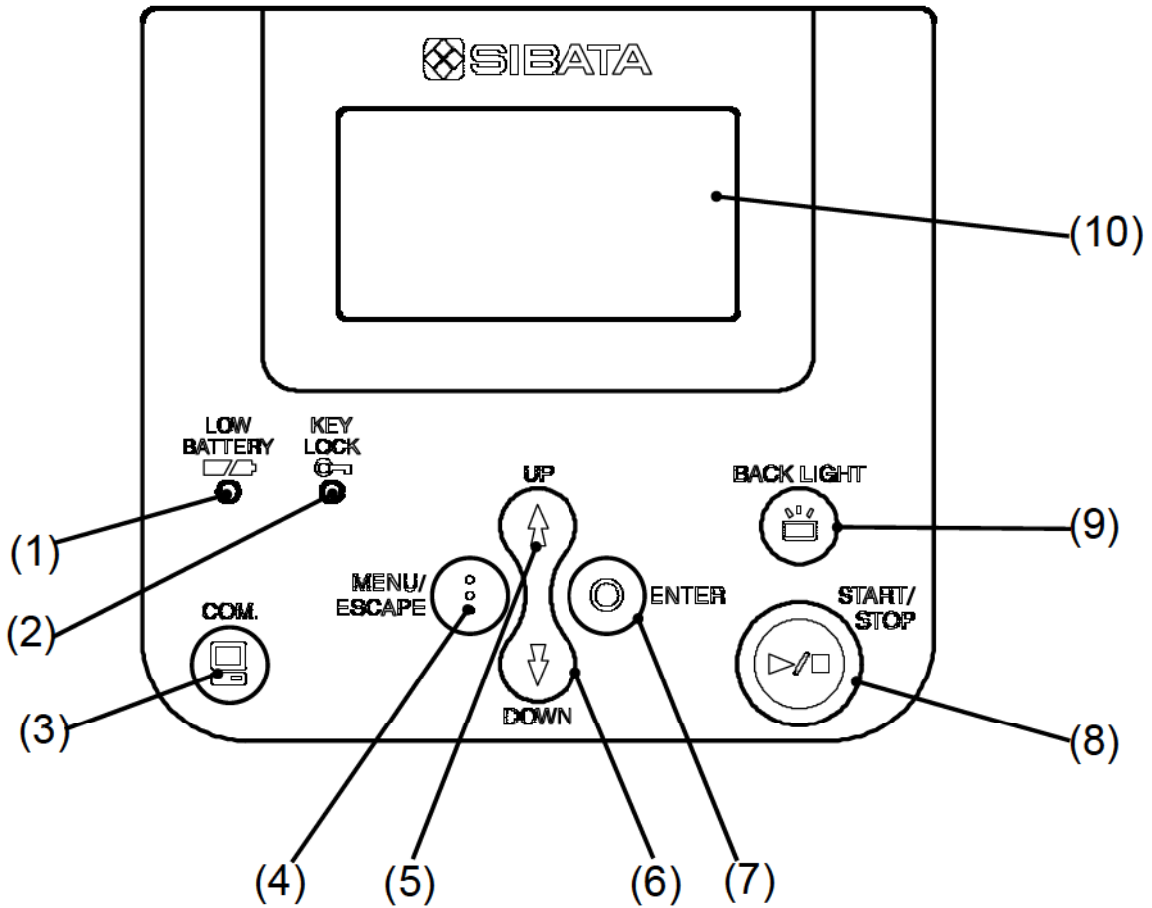

- (1) LOW BATTERY : Battery out caution lamp
- (2) KEY LOCK : Key lock lamp
- (3) COM. : COM key. This is used to output data to a PC, etc.
- (4) MENU/ESCAPE : Menu, escape key
- (5) UP : Key for incrementing set values
- (6) DOWN : Key for decrementing set values
- (7) ENTER : Enter key
- (8) START/STOP : Measurement start/stop key
- (9) BACK LIGHT : LCD backlight key
- (10) LCD screen : LCD screen display

Instructions for Use

Installation Procedure

Install this equipment at a flat, stable location. To prevent it from overturning, be sure to fasten it by staking the legs of the stand to the floor.

There are four anchor bolt holes in the bottom of the stand, and eight rope fastening holes in the stand support column.

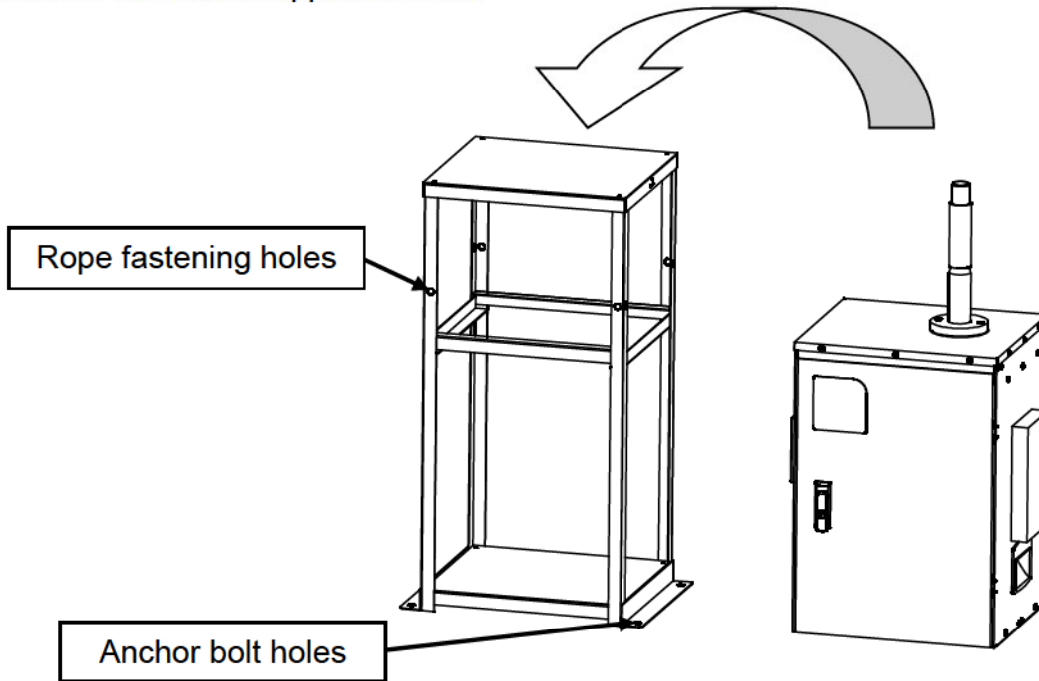

After installing the stand, place the sampler unit on it.

Lock the grips on the twist fasteners on the left and right sides of the main unit, fastening the main unit to the stand.

Check that the twist fastener grip is raised (perpendicular to the front).

As shown in the figures, place the catch into the hook, and then rotate the grip 180 degrees. The fastener will now be hooked, so lower the grip.

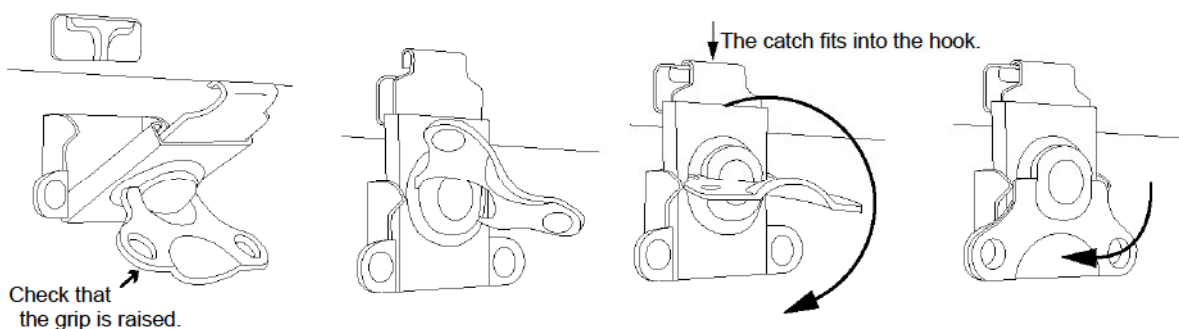

Note: The eye bolts in the main unit top are used when fastening the air inlet port with ropes. Never use these to fasten the main unit.

Note: Do not transport the equipment when the main unit is attached to the stand. This is dangerous, as there is a risk that the grips will be damaged.

Wiring Procedure

The main unit can be used with a single-phase 100 V to 240 V (85 V to 264 V) power source. It can be used with voltages other than 100 V. However, **the power outlet noted below will not be compatible**. Replace the power outlet with one suited to the applicable voltage. For safety's sake, contact your Sibata representative or the vendor if you will be using the equipment at a voltage other than 100 V. Also, **be sure to ground the power supply**.

If you are using this product outdoors, be sure that the outlet and extension cord used are waterproof. This product uses a Panasonic WF7515K waterproof plug. Using a Panasonic **WA3519K waterproof outlet** with the same rating as the inlet will ensure that the plug and outlet section is thoroughly waterproof.

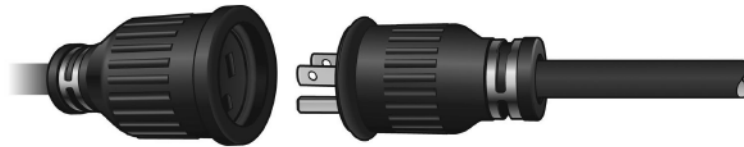

Note: Ensure that the power supply has sufficient electrical capacity. Two to three times the regular power consumption occurs in the instant directly after startup.

Note: Do not connect the power adapter to a multi-plug power strip. Doing so might cause electric shock or fire.

Note: Be sure to ground this product. Failure to do so might cause electric shock, malfunction, or fire.

Note: Check that the power cord is securely connected to the product. If the connection is loose, it will not be waterproofed, which might cause electric leak or malfunction.

Note: If you are using it at a different voltage, it may not be possible to waterproof the outlet installed, depending on its shape. Pay attention to the specifications when wiring the equipment.

Installing and Cleaning the PM10 Impactor

The PM10 impactor can be disassembled as described below.

Hold the upper section of the PM10 impactor (the parasol-shaped end) securely. Rotate the lower section of the impactor counterclockwise, and then remove it.

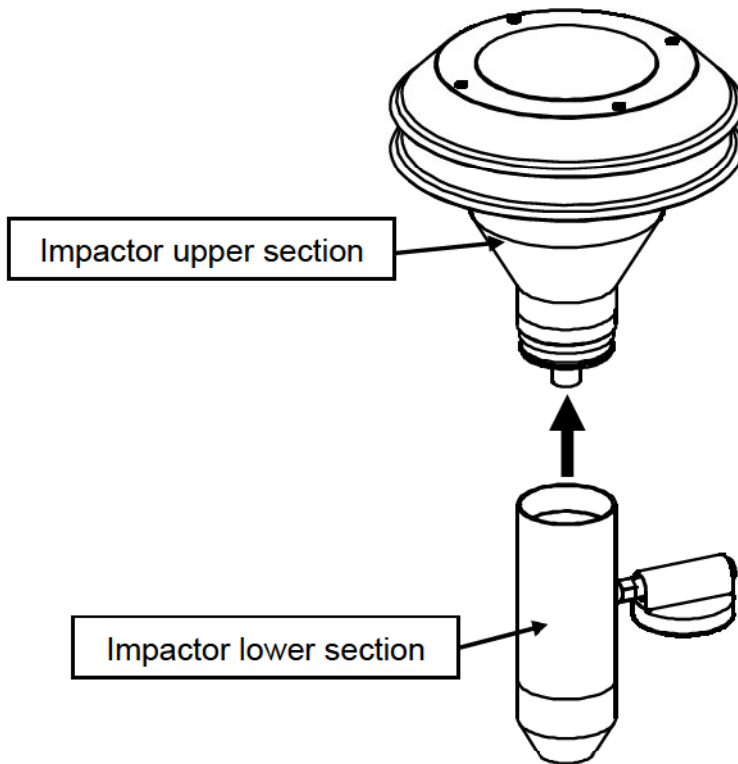

If the interior is dirty, clean it with a soft cloth or paper, or by using pure water to damp them. If the dirt resists cleaning with pure water, use ethanol or acetone.

Coarse dust may adhere to the mesh over the suction port at the top of the impactor, so give it a quick clean with an air blower.

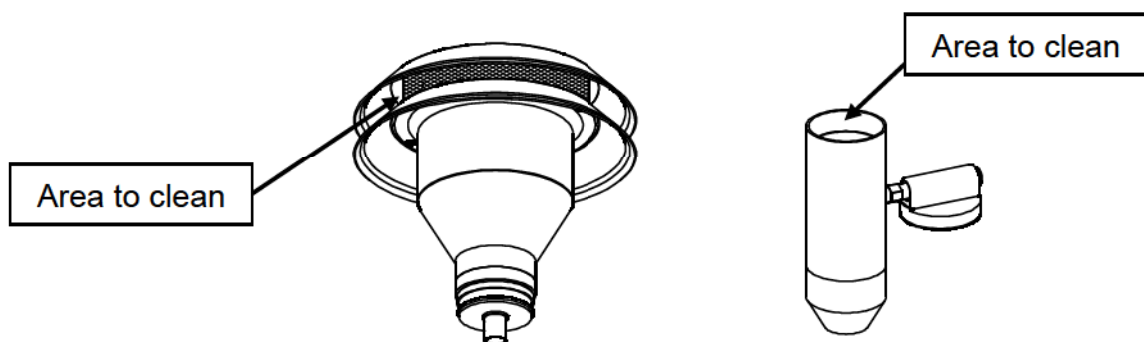

Reverse the procedure to reassemble the impactor.

Attach the glass rainwater trap to the reassembled PM10 impactor. At this point, check that the packing is attached securely.

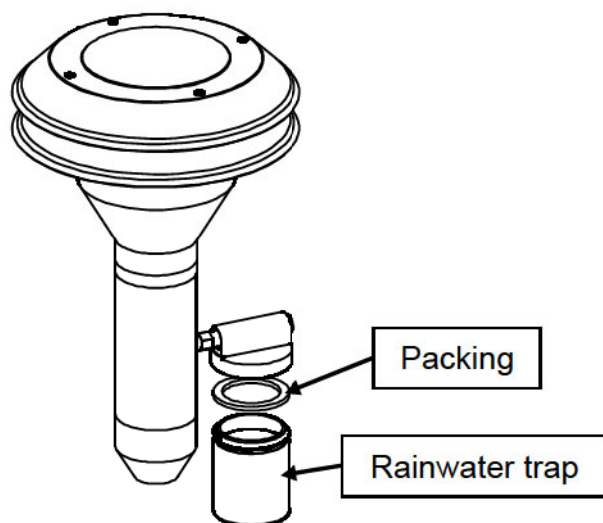

Insert the PM10 impactor, with the rainwater trap attached, into the inlet pipe on the top of the main unit. Insert it securely, all the way in.

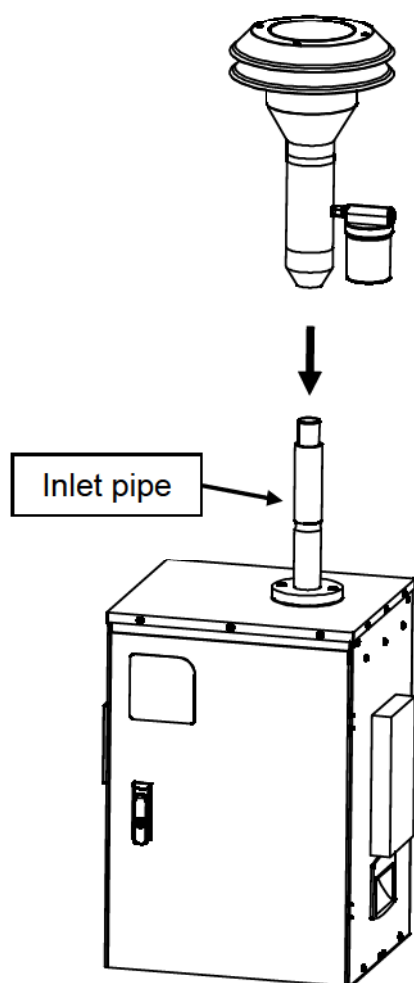

As shown in the figure, attach the ambient temperature sensor to the right side when facing the main unit. After adjusting the position of the ambient temperature sensor, tighten the wing nut securely to fasten the sensor.

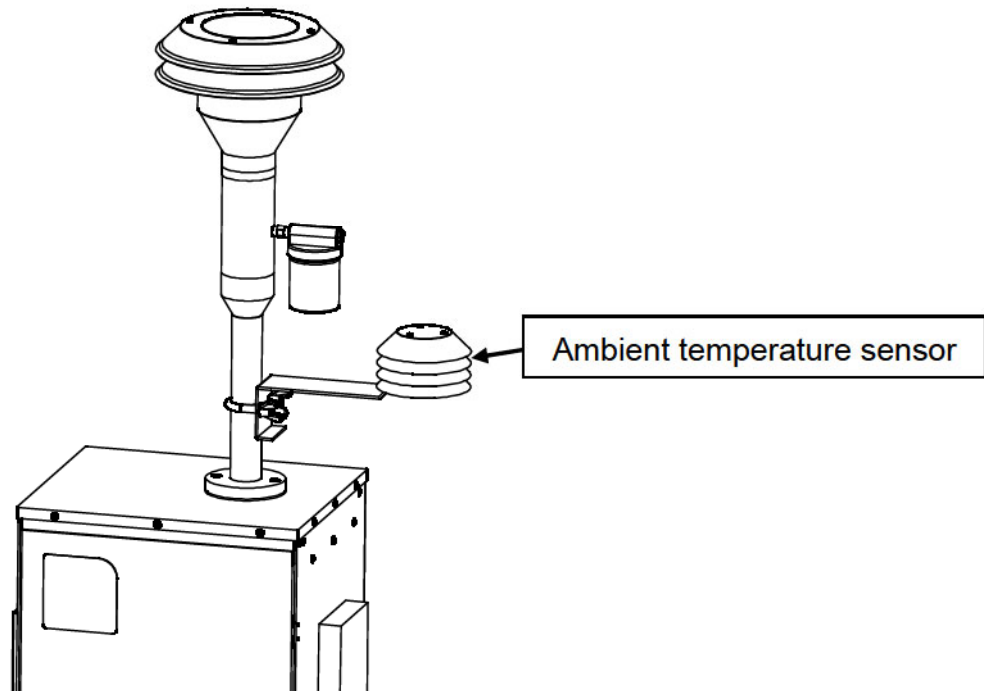

Connect the cable for the ambient temperature sensor to the connector on the back of the main unit. Align the cable with the connector port, and insert the cable until you hear a click.

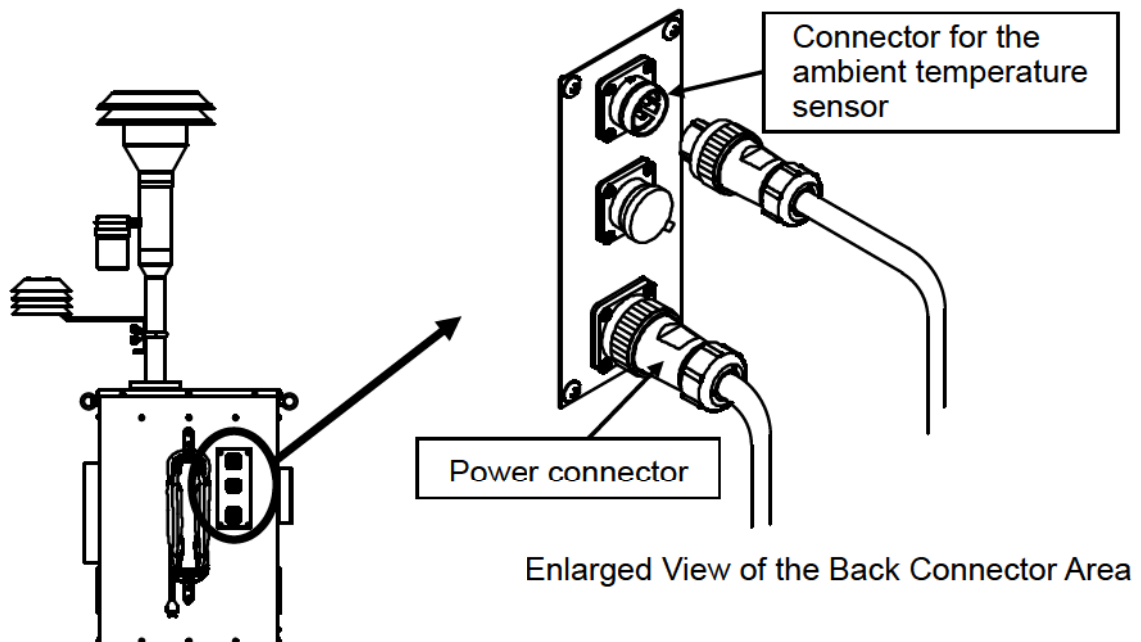

Note: If the sampling height will be 3 m, attach the sampling pipe joint (custom-ordered) to the top of the inlet pipe on top of the main unit. Then connect a 1-m sampling pipe (custom-ordered), and attach the PM10 impactor onto this. In this case, the eye bolts on the top of the main unit should be used to fasten the sample air inlet port with ropes.

Removing the Filter holder support and PM2.5 Impactor

Open the door on the main unit. Remove the PM2.5 impactor and the filter holder support installed inside.

Unfasten the catch clips on the left and right sides of the filter holder support.

Lower the lower section of the filter holder support, and remove the filter holder from inside.

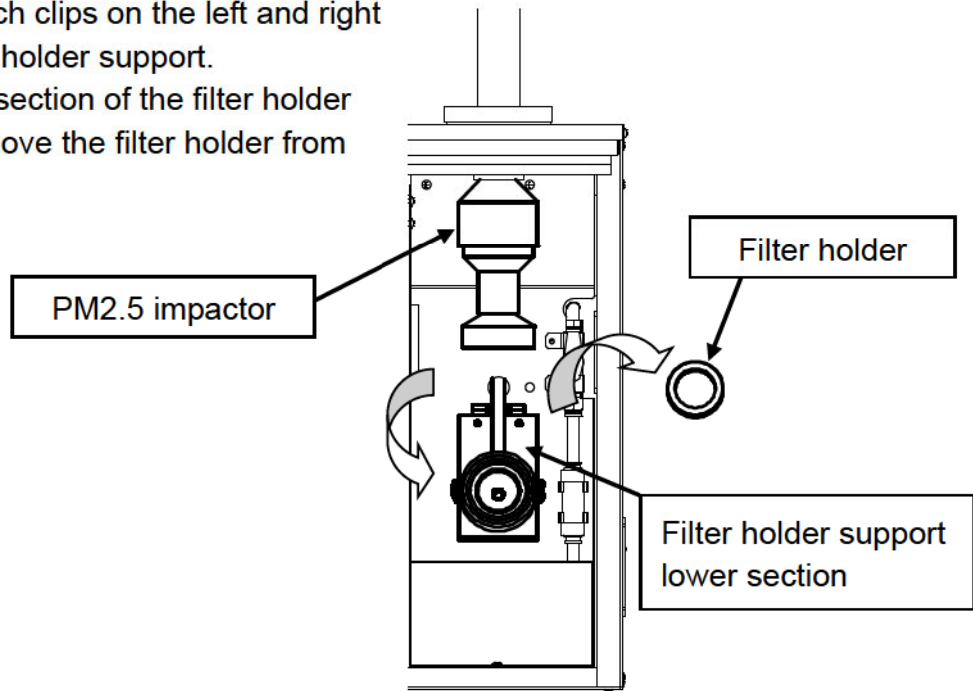

Hold the PM2.5 impactor securely. Slowly extract the upper section of the filter holder support and remove it.

In the same way, extract the PM2.5 impactor.

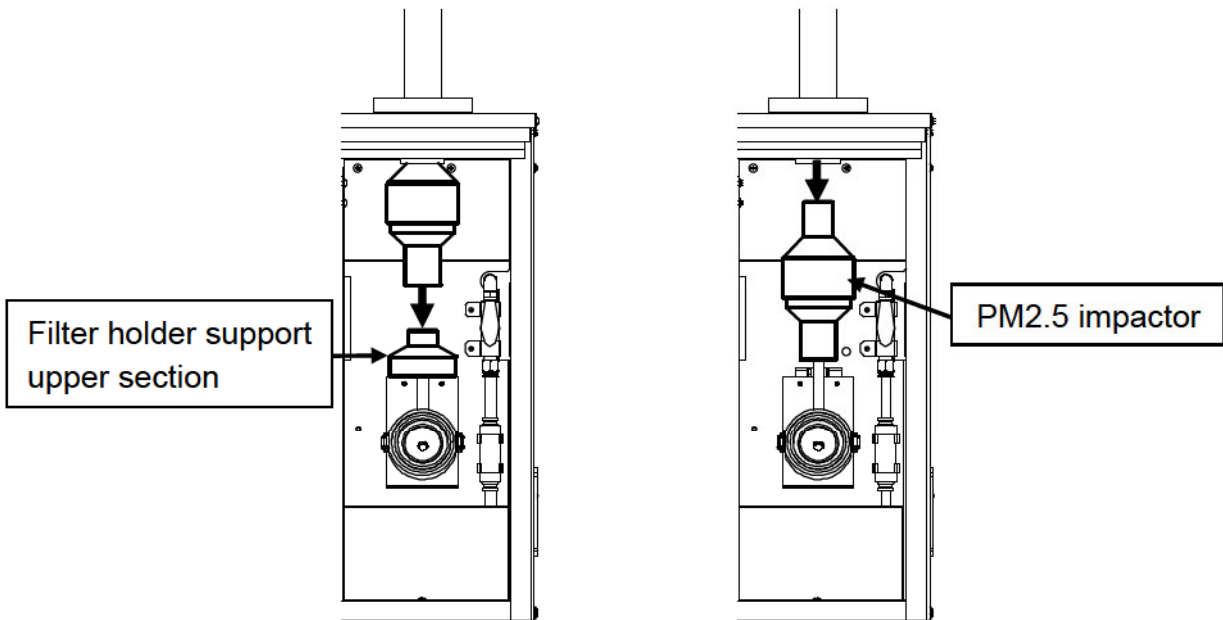

Note: The PM2.5 impactor and the upper section of the filter holder support are fastened with an O-ring. It may be a little stiff, but if you use too much force to withdraw it, you may end up colliding with the lower section of the filter holder support, hurting yourself. Be very careful when handling these components.

Replacing the PM2.5 Impactor

To maintain the particle-sizing characteristics at 2.5 μm and 50 % cut by using the PM2.5 impactor, mount the impactor filter (a $\phi 37\text{-mm}$ fiberglass filter) in the impactor well (coarse particle catcher). Then cover the filter surface with a layer of impactor oil to prevent the re-scattering of coarse particles.

While holding the lower section of the PM2.5 impactor, rotate the upper section of the impactor counterclockwise. Loosen the screws and separate the upper and lower sections of the impactor.

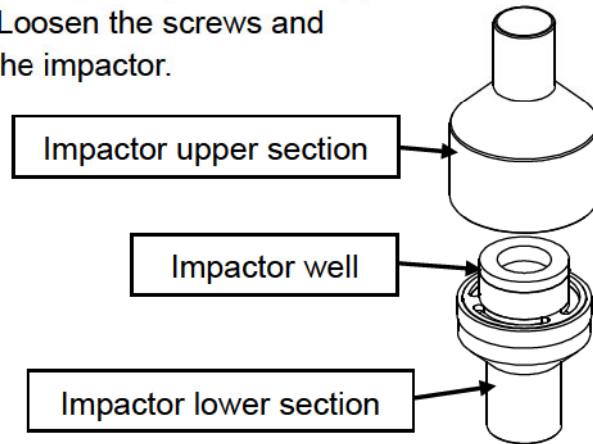

Note: The impactor well (coarse particle catcher) is placed on top of the lower section of the PM2.5 impactor. Be careful not to drop the impactor well when the upper and lower sections of the impactor are separated.

Separate the upper and lower sections of the PM2.5 impactor well.

Attach the impactor filter ($\phi 37\text{-mm}$ fiberglass filter) onto the catcher at the lower section of the PM2.5 impactor well. Drop 1 mL of impactor oil onto the surface of the filter to coat it with a layer of oil.

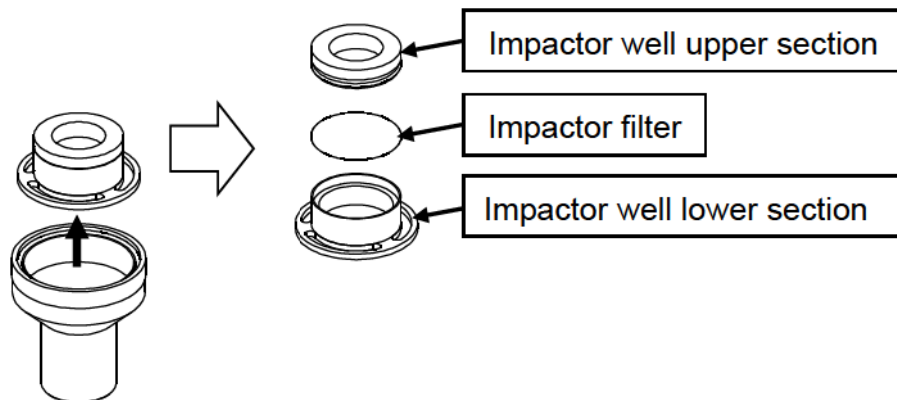

Reverse the procedure to reassemble the impactor well. Attach each part carefully, ensuring an airtight seal.

Note: To minimize the re-scattering of coarse particles and changes in sizing characteristics as the inside of the PM2.5 impactor becomes dirty, replace the impactor filter and clean the inside of the impactor about once per week. Clean it with soft cloths or paper, or by using pure water to damp them. If the dirt resists cleaning with pure water, use ethanol or acetone.

Replacing the Filter Holder

The filter holder is structured as shown in the figure below.

As shown in the figure, position the filter, and then attach the filter clamp.

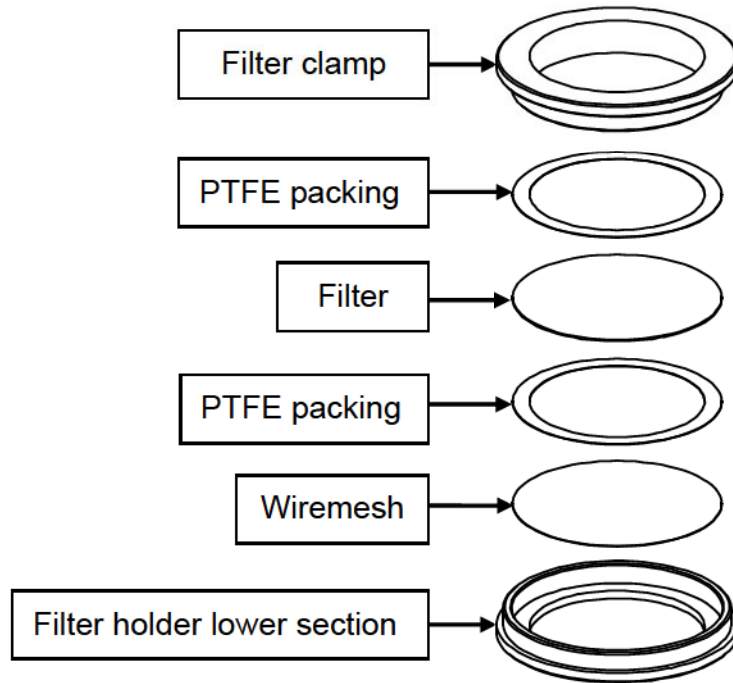

When positioning the quartz fiberglass filter, first place PTFE packing on top of the wire mesh, followed by the filter, and then more PTFE packing.

PTFE packing does not need to be used if a PTFE filter is used.

Note: Be sure to attach a filter before operating the sampler.

Never operate the equipment if there is no filter inside the filter holder.

Attaching the Filter holder support and PM2.5 Impactor

With the lower section of the filter holder support lowered, insert the PM2.5 impactor all the way into the hole in the upper section of the main unit.

Next, attach the upper section of the filter holder support by inserting it into the lower section of the PM2.5 impactor.

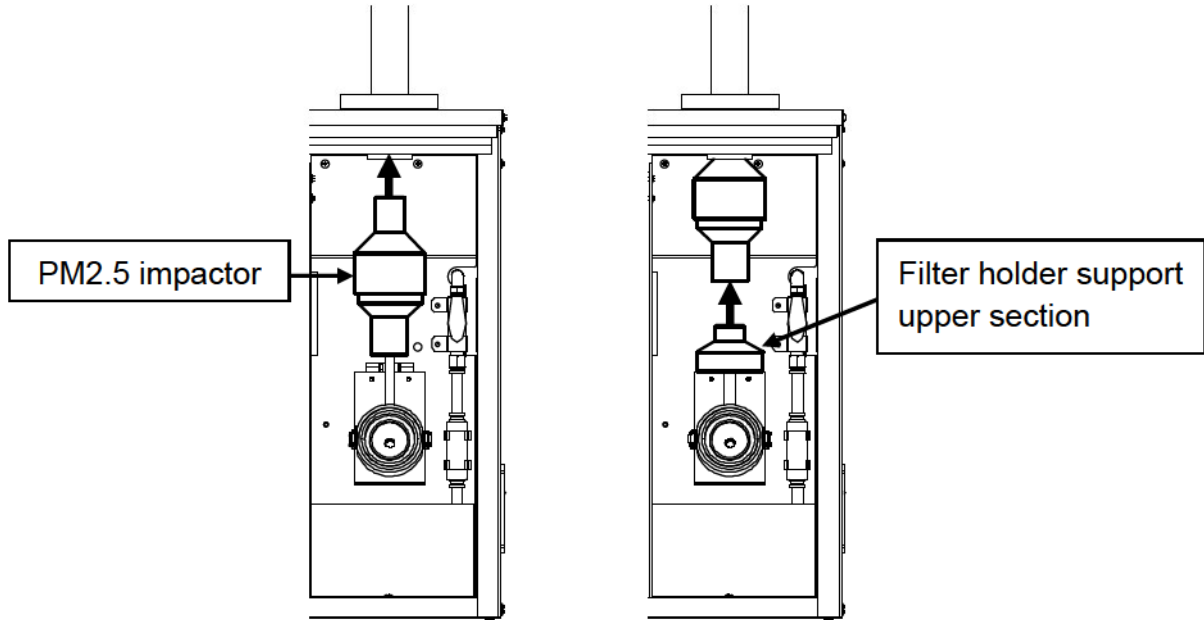

Place the filter holder on the lower section of the filter holder support. Raise the lower section of the filter holder support until it touches the upper section of the filter holder. Securely fasten the catch clips on the left and right of the filter holder support. Rotate the upper section of the filter holder support to adjust the alignment of the catch clips.

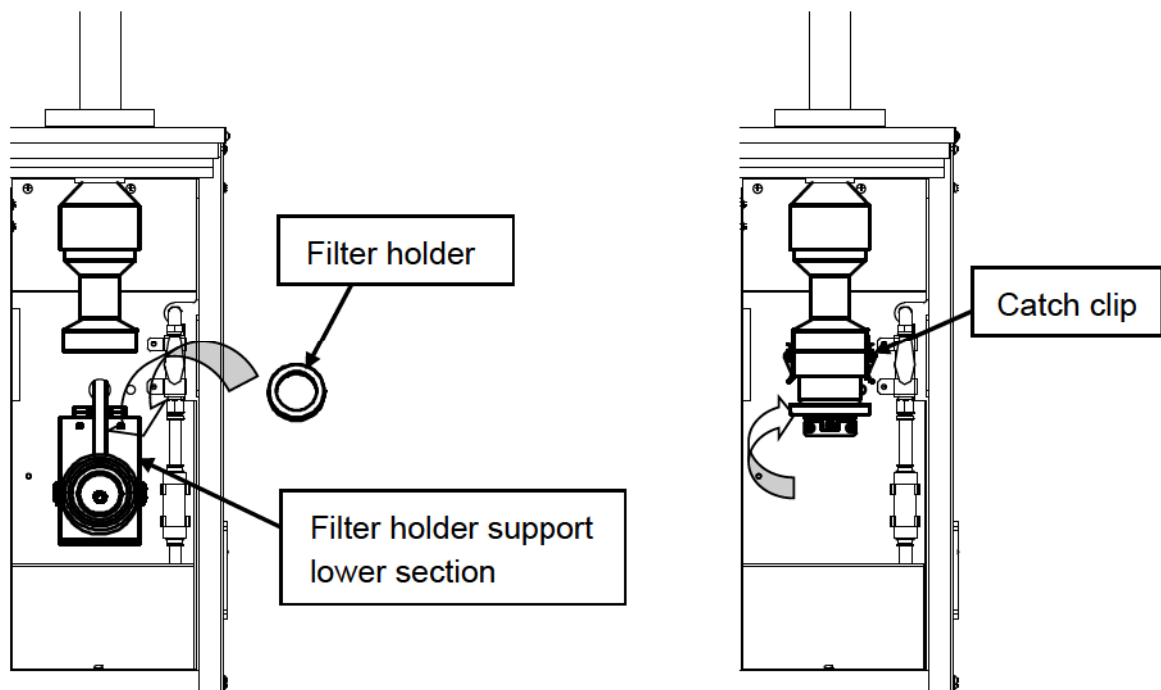

Plug Valve

Check that the plug valve is positioned vertically (valve open position) as shown in the figure. If it is horizontal, the plug valve will be closed.

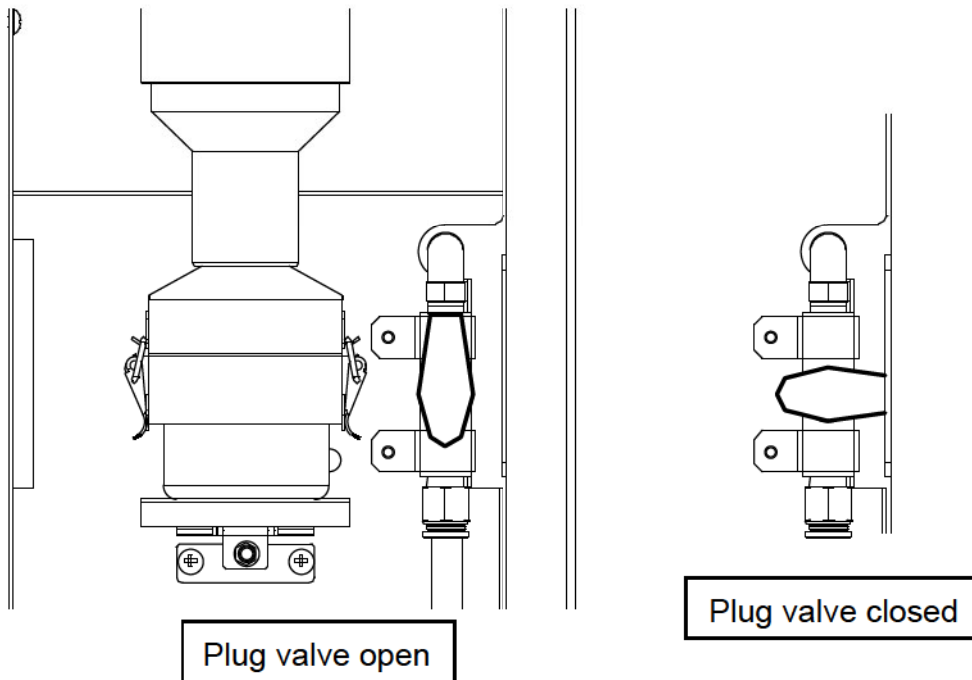

Note: Never perform sampling with the plug valve closed. This will cause malfunctions.

Airtight Test

Airtight tests can be performed by attaching a hose joint (optionally available, item code: 080180-2525) and manual vacuum pump (optionally available, item code: 080870-10) using the tube as shown in the figure.

- (1) Close the plug valve.
- (2) Using the manual vacuum pump, apply suction until approximately 0.04 MPa is reached.
- (3) Release the handle on the manual vacuum pump. Check that the needle on the pressure gauge does not drop (check that there is no leak).
- (4) After finishing the airtight test, reopen the plug valve.

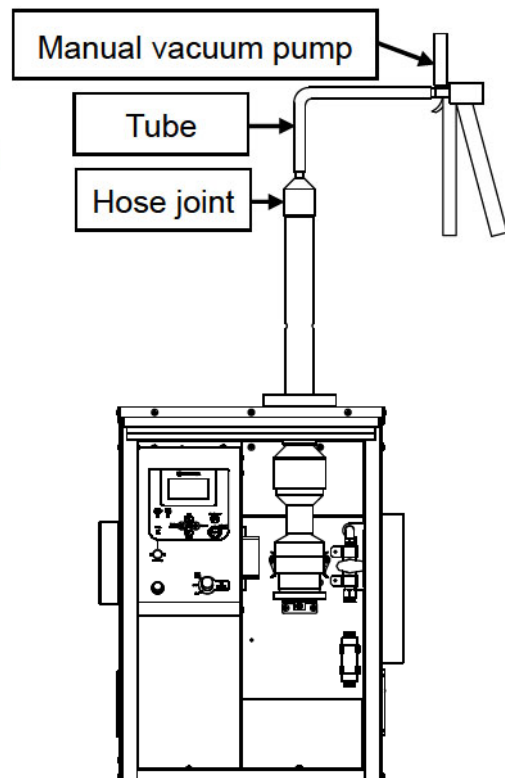

How to Operate the Control Panel

1. Power Switch

Before inserting the power cord into the power outlet, be sure to set the power switch to the OFF position.

Power is turned ON by turning the key switch to the right from the OFF position. The version is first displayed on the LCD screen, followed by the main screen (preset flow rate). After this, the LV-250R can be operated.

When the key switch is turned right from the ON position, the keys are in a locked state. In this state, the switches on the panel sheet do not operate even if pressed. In this state, the [KEY LOCK] lamp lights.

Note: When the keys are in a locked state, make sure that the backlight is out.

When canceling the key lock, take care not to turn the key switch to the OFF position by mistake.

2. Backlight

Pressing the [BACK LIGHT] key on the control panel turns the LCD backlight ON. Pressing the key again turns the backlight OFF.

3. Data Output

Data can be output to a PC or other external device by pressing the [COM] key. For details, refer to the operation manual for the data output software (Communication cable with software for LV-250/LV-40B).

How to View the LCD

Two types of screens are displayed on the LCD, the main and main menu screens.

1. Main Screen

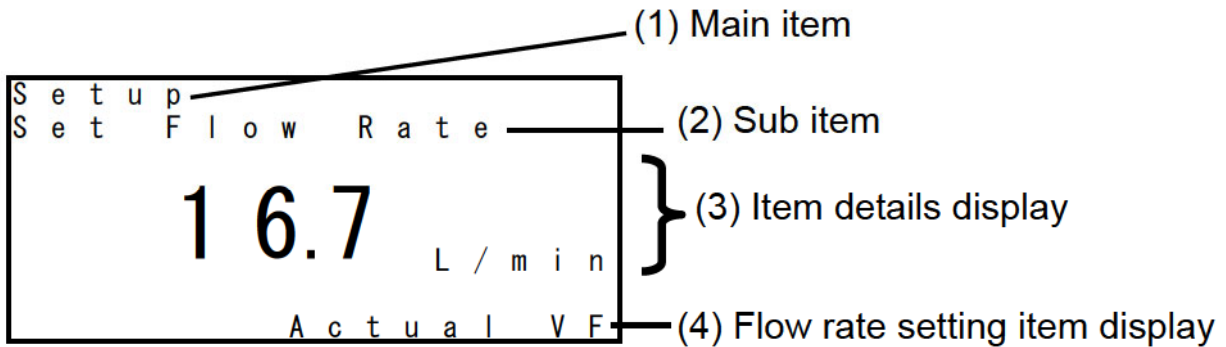

This is the basic screen that is displayed when the power is turned ON or an item is selected on the menu.

- (1) indicates the item currently selected in the main menu.
- (2) indicates the item in the sub-menu selected at the respective item.
(2) is sometimes displayed spread over two lines or not displayed.
- (3) indicates the item setting in large numbers. The unit is also displayed in smaller letters.
- (4) indicates the result of conversion to the actual volume flow rate or standard state when the flow rate is displayed, or preset details. (⇒ For details, see P36.)

2. Main Menu Screen

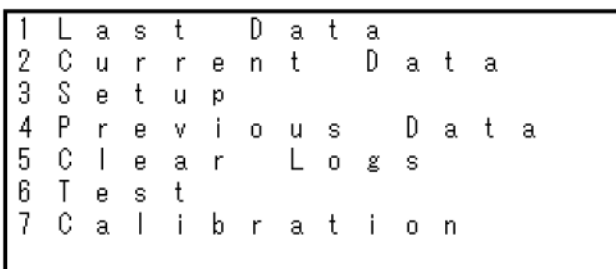





This screen displays menus spread over several lines. Items can be selected by the [UP] and [DOWN] keys. The currently selected item is displayed with its number highlighted.

Sampling Method (Basic Operations)

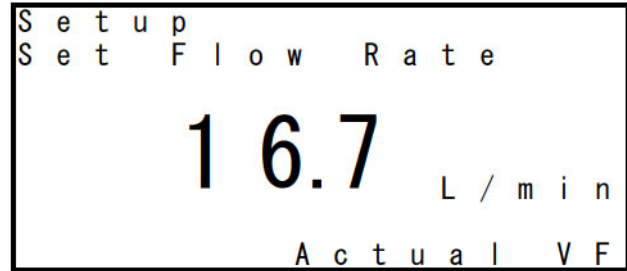
This chapter describes the basic operations for running this sampler. For detailed operations, or functions not described in this chapter, see the following chapters.

1. Turn the [POWER] switch key to the ON position. When the power is turned ON, the version is displayed, followed by the main screen as shown on the right. In this state, press the  [MENU/ESCAPE] key.



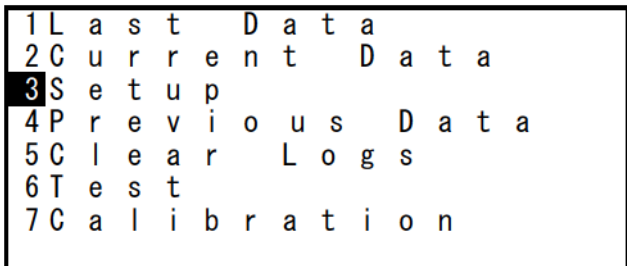

2. The main menu is displayed. Press the  [UP] Key and the  [DOWN] key. At this item, press the  [ENTER] key.



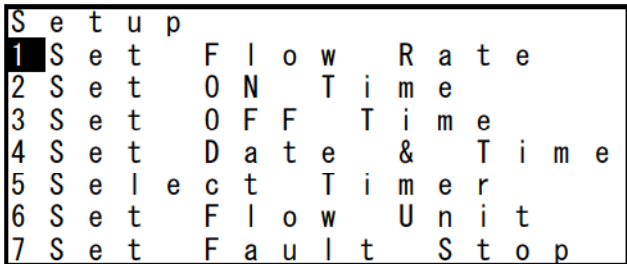

3. The Setup sub-menu is displayed as shown on the right.





Suction Flow Rate Setting

1. Press the  [UP] and  [DOWN] keys to select "1 Set Flow Rate," and press the  [ENTER] key.

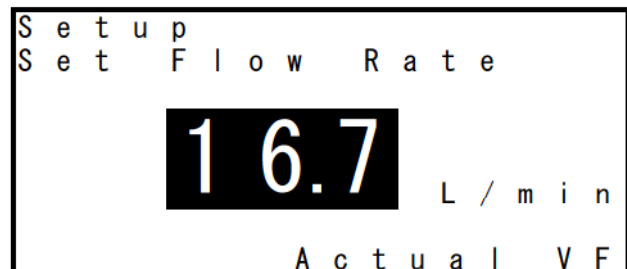
2. The current suction flow rate setting is displayed highlighted as shown in the figure on the right. Press the  [UP] and  [DOWN] keys to increment/decrement the set value in 0.1 L/min units. When the desired setting value is set, be sure to press the  [ENTER] key. The newly set value is entered, and the screen returns to the Setup sub-menu.



* After setting a new value, if the  [MENU/ESCAPE] key is pressed before the  [ENTER] key is pressed, the screen will return to the Setup sub-menu without the newly entered value being accepted.

Timer Selection

When "5 Select Timer" is selected in the Setup sub-menu, a type of ON timer and OFF timer can be selected.

There are three types of ON timers as shown below: Manual, Delay Time and Start Time.

Manual timer	This is used to manually operate the pump. Sampling is started when the  [START/STOP] key is pressed in the main screen display. When "Manual" is selected, data is not logged in chronological order at 1-minute intervals. (⇒ For details, see P49.)
Delay Time timer	This is the delay time timer. This is used to start sampling after the preset time has elapsed. (Example: Start sampling in 30 minutes from the current time.) The setting range is 0.00 to 999.59 (hours.minutes).
Start Time timer	This is the start time timer. This is used when setting the sampling start time. (Example: Start sampling at 11/10/28 10:00.)



There are four types of OFF timers as shown below: Manual, Run Time, Stop Time, and Total Volume.

Manual timer	This is used to manually operate the pump. Sampling is executed until the  [START/STOP] key is pressed during sampling. Data is not logged in chronological order at 1-minute intervals. (⇒ For details, see P49.)
Run Time timer	This is the run time timer. This is used to stop sampling after the preset time has elapsed. (Example: Stop sampling in 40 minutes.) The setting range is 0.01 to 999.59 (hours.minutes).
Stop Time timer	This is the stop time timer. This is used to stop sampling at the preset time. (Example: Stop sampling at 11/10/28 23:00.)
Total Volume timer	Total flow rate timer. This is used to stop sampling when the preset total flow rate value is reached. The setting range is 0.001 to 999.999 (m ³). When "Total Volume" is selected, data is not logged in chronological order at 1-minute intervals. (⇒ For details, see P49.)

* If a power failure occurs when performing sampling with the ON timer set to "Manual" and OFF timer set to "Manual" or "Total Volume," all measurement data before the power failure will be lost. (⇒ For details, see P49.)

Sampling Start Time Setting (ON Timer)



When "2 Set ON Time" is selected in the Setup menu, the sub-menu shown on the right is displayed and you can set the sampling start time (ON timer).

There are two types: "1 Delay Time" and "2 Start Time." Select either of these types by the  [UP] and  [DOWN] keys, and press the  [ENTER] key.

```
S e t u p
S e t   O N   T i m e
1 D e l a y   T i m e
2 S t a r t   T i m e
```

[1] Delay Time Timer Setting (Delay Time)

When "1 Delay Time" is selected, the "hours" digits are displayed highlighted as shown on the right.

Press the  [UP] and  [DOWN] keys to set the hours.



When the setting is finished, press the  [ENTER] key.

Next, the "minutes" digits are displayed highlighted. Set the values in the same way.

When the setting is finished, press the  [ENTER] key. The newly set value is entered, and the screen returns to the sub-menu.



```
S e t u p   O N   T i m e
S e t   D e l a y   T i m e
9 9 9 . 5 9
      h r s   m i n
```



```
S e t u p   O N   T i m e
S e t   D e l a y   T i m e
9 9 9 . 5 9
      h r s   m i n
```

* After setting a new value, if the  [MENU/ESCAPE] key is pressed before the  [ENTER] key is pressed, the screen will return to the Setup sub-menu without the newly entered value being accepted.



[2] Start Time Timer Setting (Start Time)

When "2 Start Time" is selected, the "year" digits are displayed highlighted as shown on the right.

Press the  [UP] and  [DOWN] keys to set the year. When the setting is finished, press the  [ENTER] key. Next, the "month" digits are displayed highlighted.

Set the values in the same way and press the  [ENTER] key. Then, set "day," "hours," and "minutes" in this order. Last of all, when the "minutes" setting is changed and the  [ENTER] key is pressed, the newly set values are entered, and the screen returns to the sub-menu.

```
S e t u p   O N   T i m e
S e t   S t a r t   T i m e
0 2 / 0 1 / 0 1
0 0 : 0 0 : 0 0
```

* The setting range for "year" is 02 to 65 (2002 to 2065). The "seconds" setting is fixed at "00" and cannot be changed. After changing the "minutes" setting, if the  [MENU/ESCAPE] key is pressed before the  [ENTER] key is pressed, the screen will return to the Setup sub-menu without the newly entered value being accepted.

Sampling Stop Time Setting (OFF Timer)

When "3 Set OFF Time" is selected in the Setup menu, the sub-menu shown on the right is displayed and you can set the sampling stop time (OFF timer).

There are three types: "1 Run Time," "2 Stop Time," and "3.Total Volume." Select one of these types by the [UP] and [DOWN] keys, and press the [ENTER] key.

```

S e t u p
S e t   O F F   T i m e
1 R u n   T i m e
2 S t o p   T i m e
3 T o t a l   V o l u m e
    
```

[1] Run Time Timer Setting (Run Time)

When "1 Run Time" is selected, the "hours" digits are displayed highlighted as shown on the right.

Press the [UP] and [DOWN] keys to set the hours. When the setting is finished, press the [ENTER] key.

Next, the "minutes" digits are displayed highlighted. Set the values in the same way.

When the setting is finished, press the [ENTER] key. The newly set value is entered, and the screen returns to the sub-menu.

```

S e t u p   O F F   T i m e
S e t   R u n   T i m e

9 9 9 . 5 9
   h r s   m i n
    
```

```

S e t u p   O F F   T i m e
S e t   R u n   T i m e

9 9 9 . 5 9
   h r s   m i n
    
```

* After setting a new value, if the [MENU/ESCAPE] key is pressed before the [ENTER] key is pressed, the screen will return to the Setup sub-menu without the newly entered value being accepted.

[2] Stop Time Timer Setting (Stop Time)

When "2 Stop Time" is selected, the "year" digits are displayed highlighted as shown on the right.

Press the [UP] and [DOWN] keys to set the year. When the setting is finished, press the [ENTER] key. Next, the "month" digits are displayed highlighted.

Set the values in the same way and press the [ENTER] key. Then, set "day," "hours," and "minutes" in this order. Last of all, when the "minutes" setting is changed and the [ENTER] key is pressed, the newly set values are entered, and the screen returns to the Setup sub-menu.

```



S e t u p   O F F   T i m e
S e t   S t o p   T i m e

0 2 / 0 1 / 0 1
0 0 : 0 0 : 0 0
    
```

* The setting range for "year" is 02 to 65 (2002 to 2065). The "seconds" setting is fixed at "00" and cannot be changed. After changing the "minutes" setting, if the [MENU/ESCAPE] key is pressed before the [ENTER] key is pressed, the screen will return to the Setup sub-menu without the newly entered value being accepted.

[3] Total Flow Rate Timer Setting (Total Volume)

When "3. Total Time" is selected, the digits of integer part is displayed highlighted as shown on the right.



Press the  [UP] and  [DOWN] keys to set the value.

When the setting is finished, press the  [ENTER] key.

Next, the digits of fractional part are displayed highlighted. Set the values in the same way.

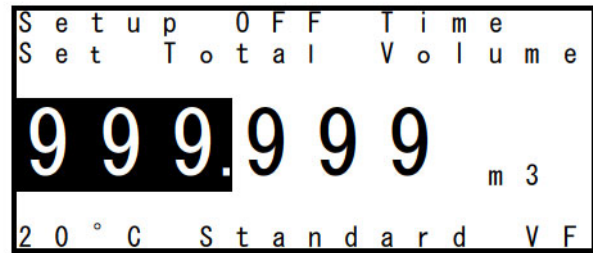
When the setting is finished, press the  [ENTER] key. The newly set value is entered, and the screen returns to the Setup sub-menu.



* After setting a new value, if the  [MENU/ESCAPE] key is pressed before the  [ENTER] key is pressed, the screen will return to the Setup sub-menu without the newly entered value being accepted.

Starting Sampling

Perform the following procedure after connecting the filter holder, etc. before the backup filter.

Press the  [MENU/ESCAPE] key several times until the screen returns to the main screen.

When the screen returns to the main screen, "Setup Set Flow Rate" is initially displayed. Make sure that the set flow rate is correct.

Pressing the  [DOWN] key displays "Setup ON Time" and "Setup OFF Time" in this order. Make sure that each set value is correct.

If all settings are OK, press the  [START/STOP] key. Sampling is started.

When the ON timer is set, the time remaining until sampling is started will be displayed.

When sampling ends successfully, the screen will change as shown on the right. Press the  [DOWN] key to return to the main screen.

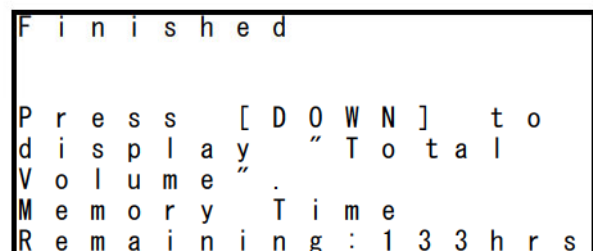

This completes the series of operations.

For detailed operations and other functions, see the following chapters.

Operation Methods

Overview of Screen Display

[1] Main Screen (Before Sampling)

When the sampler is turned ON, "Setup Set Flow Rate" is initially displayed. The display changes in the order shown in the table below by pressing the [UP] and [DOWN] keys. When the display progresses to "Current Date and Time," it returns to "Setup Set Flow Rate." After sampling ends, the display begins with "Last Data Total Volume." When the [START/STOP] key is pressed with "Last Data Total Volume" displayed, sampling begins. When the [MENU/ESCAPE] key is pressed, the main menu is displayed.

Main Screen Display (Before Sampling)

Display	Description
Setup Set Flow Rate	Sets the suction flow rate. (⇒ See P28.)
Setup ON Time	Sets the ON timer. (⇒ See P28.)
Setup OFF Time	Sets the OFF timer. (⇒ See P28.)
Last Data Total Volume	Displays the latest total flow rate value. (⇒ See P28.)
Last Data Total Samp. Time	Displays the latest sampling time. (⇒ See P28.)
Current Date and Time	Sets the current date/time. (⇒ See P28.)

Main Menu

To move to a respective sub-menu, press the [UP] and [DOWN] keys to select the item, and press the [ENTER] key. Press the [MENU/ESCAPE] key to return to the main screen.

Main Menu Display (Before Sampling)

Display	Description
1 Last Data	Displays the sub-menu for displaying the latest measurement value. (⇒ See P29.)
2 Current Data	Displays the current ambient pressure and temperature. (⇒ See P31.)
3 Setup	Sets the flow rate (including unit), timer, time, fault stop, etc.). (⇒ See P32.)
4 Previous Data	Displays past measurement values in chronological order. (⇒ See P38.)
5 Clear Logs	Clears memory. (⇒ See P38.)
6 Test	Checks the device (pump operating time, pump power voltage). (⇒ See P39.)
7 Calibration	Displays the calibration menu. (⇒ See P39.)

[2] Main Screen (Standby for Sampling Start)

When the ON timer is set, the sampler stands by for start of sampling (standby for pump startup). When the [START/STOP] key is pressed in the main screen display, the pump stands by for startup. Initially, "Waiting Time Remaining" is displayed. The display is switched to "Waiting Set ON Time" by pressing the [UP] and [DOWN] keys. If the [START/STOP] key is pressed while the sampler is standing by for start of sampling, the timer will be canceled. If the timer is canceled before start of sampling, the total flow rate and other values will remain at their values for the previous measurement.

Main Screen Display (Standby for Sampling Start)

Display	Description
Waiting Time Remaining	Displays the time remaining until start of sampling. (⇒ See P43.)
Waiting Set ON Time	Displays the ON timer setting. (⇒ See P43.)

When the [MENU/ESCAPE] key is pressed, the main menu is displayed.

Only "Setup" can be selected. (⇒ See P43.)

Press the [ENTER] key to move to a respective sub-menu. Press the [MENU/ESCAPE] key to return to the main screen.

[3] Main Screen (During Sampling)

When sampling is started (i.e. pump operation is started), "Sampling Live Flow Rate" is initially displayed. The display changes in the order shown in the table below by pressing the [UP] and [DOWN] keys. When the display progresses to "Current Date and Time," it returns to "Sampling Live Flow Rate." If the [START/STOP] key is pressed in the main screen display during sampling, the timer will be canceled and sampling will be stopped even if timer operation is in progress. Even if sampling is stopped midway, the measurement values during sampling will be recorded.

Main Screen Display (During Sampling)

Display	Description
Sampling Live Flow Rate	Displays the instantaneous flow rate. (⇒ See P44.)
Sampling Total Volume	Displays the total flow rate. (⇒ See P44.)
Sampling Total Samp. Time	Displays the sampling time. (⇒ See P44.)
Sampling Time Remaining	Displays the remaining sampling time. (⇒ See P44.)
Current Date and Time	Displays the current date/time. (⇒ See P44.)

When the [MENU/ESCAPE] key is pressed, the main menu is displayed.

To move to a respective sub-menu, press the [UP] and [DOWN] keys to select the item, and press the [ENTER] key. Press the [MENU/ESCAPE] key to return to the main screen.

Main Menu Display

Display	Description
2 Current Data	Displays the current value. (⇒ See P45.)
3 Setup	Displays the set value. (⇒ See P47.)

Before Sampling

Main Screen

[1] Setup Set Flow Rate (Suction Flow Rate Set Value)

This displays the suction flow rate set value. On the last line, for the actual volume flow rate, "Actual VF" is displayed, and for the volume flow rate after conversion to the standard state, the standard temperature and "Standard VF" are displayed.

(⇒ For details, see P36.)

```
S e t u p
S e t   F l o w   R a t e
      1 6 . 7   L / m i n
      A c t u a l   V F
```

[2] Setup ON Time (ON Timer Set Value)

One of the ON timer settings - Manual, Delay Time and Start Time - preset at "Select Timer" is displayed. The figure on the right is a display example for when "Manual" is selected.

```
S e t u p   O N   T i m e
M a n u a l
      _ _ _   _ _ _
      h r s   m i n
```

[3] Setup OFF Time (OFF Timer Set Value)

One of the OFF timer settings - Manual, Run Time, Stop Time and Total Volume - preset at "Select Timer" is displayed. The figure on the right is a display example for when "Run Time" is selected.

```
S e t u p   O F F   T i m e
S e t   R u n   T i m e
      8 . 0 0
      h r s   m i n
```

[4] Last Data Total Volume (Latest Total Flow Rate)

The latest (previous) sampled total flow rate value is displayed.

On the last line, for the actual volume flow rate, "Actual VF" is displayed, and for the volume flow rate after conversion to the standard state, the standard temperature and "Standard VF" are displayed.

(⇒ For details, see P36.)

```
L a s t   D a t a
T o t a l   V o l u m e
      1 0 . 5 0 0   m 3
2 0 ° C   S t a n d a r d   V F
```

[5] Last Data Total Samp. Time (Latest Sampling Time)

The latest (previous) sampling time is displayed.

[6] Current Date and Time (Current Date/Time)

The current date/time is displayed in the format year/month/day hours:minutes:seconds. The year and time are displayed by the lower two digits of the calendar year and in 24-hour units, respectively.

Main Menu

1 Last Data (Latest Measurement Value)

The latest (previous) measurement value is displayed with the Last Data menu. When "1. Last Data" is selected in the main menu, the following sub-menu is displayed. Select the menu in the same way as for the main menu. Press the [MENU/ESCAPE] key several times according to the screen display until the display returns to the main screen.

Last Data Menu Display

Display	Description
1 Total Volume	Displays the total flow rate.
2 Flow Rate	Displays the suction flow rate (average, fluctuation coefficient).
3 Sample Time	Displays the sampling time and sampling start/stop date/time.
4 Ambient BP.	Displays the ambient pressure (minimum, maximum, average).
5 Pressure Drop	Displays the filter pressure loss (minimum, maximum, average).
6 Temperature	Displays the ambient temperature (minimum, maximum, average), and the filter temperature (minimum, maximum, average, maximum temperature difference from ambient temperature, time and date when the maximum temperature difference from ambient temperature occurred).
7 Warning	Displays the warning (flow rate fault, filter temperature fault, sampling time fault, power failure).

● Total Volume (Total Flow Rate)

When "1 Total Volume" is selected and the [ENTER] key is pressed, the total flow rate is displayed. On the last line, for the actual volume flow rate, "Actual VF" is displayed, and for the volume flow rate after conversion to the standard state, the standard temperature and "Standard VF" are displayed. (⇒ For details, see P36.)

L	a	s	t	D	a	t	a						
T	o	t	a	V	o	l	u	m	e				
1 9.8 9 2 m ³													
2	0	°	C	S	t	a	n	d	a	r	d	V	F

● Flow Rate (Suction Flow Rate)

When "2 Flow Rate" is selected and the [ENTER] key is pressed, the Flow Rate menu is displayed. When "AVG." is selected by the [UP] and [DOWN] keys and the [ENTER] key is pressed, the average flow rate during sampling is displayed. Likewise, when "CV." is selected and the [ENTER] key is pressed, the fluctuation coefficient of the suction flow rate during sampling is displayed.

L	a	s	t	D	a	t	a
F	l	o	w	R	a	t	e
1	A	V	G	.			
2	C	V	.				

● Sample Time (Sampling Time)

When "3 Sample Time" is selected and the [ENTER] key is pressed, the Sample Time menu is displayed. When "Total," "Start," and "Stop" are respectively selected by the [UP] and [DOWN] keys and the [ENTER] key is pressed, the respective sampling time, sampling start date/time and sampling stop date/time are displayed.

● **Ambient BP. (Ambient Pressure)**

When "4 Ambient BP." is selected and the [ENTER] key is pressed, the Ambient BP. menu is displayed. When "MIN.," "MAX.," and "AVG." are respectively selected by the [UP] and [DOWN] keys and the [ENTER] key is pressed, the respective ambient pressure minimum value, maximum value and average value during sampling are displayed.

● **Pressure Drop (Filter Pressure Loss)**

When "5 Pressure Drop" is selected and the [ENTER] key is pressed, the Pressure Drop menu is displayed. When "MIN.," "MAX.," and "AVG." is selected by the [UP] and [DOWN] keys and the [ENTER] key is pressed, the respective filter pressure loss minimum value, maximum value and average value during sampling is displayed.

● **Temperature**

When "6 Temperature" is selected and the [ENTER] key is pressed, the Temperature menu is displayed. When "1 Ambient Temp (ambient temperature)" is selected by the [UP] and [DOWN] keys and the [ENTER] key is pressed, the Ambient Temp. menu is displayed. When "MIN.," "MAX.," and "AVG." are respectively selected by the [UP] and [DOWN] keys and the [ENTER] key is pressed, the respective ambient temperature minimum value, maximum value and average value during sampling are displayed.

● **Filter Temp. (Filter Temperature)**

When "6 Temperature" is selected and the [ENTER] key is pressed, the Temperature menu is displayed. When "2 Filter" is selected by the [UP] and [DOWN] keys and the [ENTER] key is pressed, the Filter Temp. menu is displayed. When "MIN.," "MAX.," and "AVG." are respectively selected by the [UP] and [DOWN] keys and the [ENTER] key is pressed, the respective filter temperature minimum value, maximum value and average value during sampling are displayed. When "MAX. dT" and "MAX. dT Time" are selected and the [ENTER] key is pressed, the maximum temperature difference between the ambient temperature and the filter temperature, and the date and time at which this maximum temperature difference occurred are displayed. Difference between the ambient temperature and the filter temperature (Filter dT) = (Filter Temp.) – (Ambient Temp.)

● **Warning**

When "7 Warning" is selected and the [ENTER] key is pressed, the Warning menu is displayed. When "Flow Rate," "Sample Time," and "Power Failure" are respectively selected by the [UP] and [DOWN] keys and the [ENTER] key is pressed, the respective warning information is displayed.

Warning Menu Display

	Warning Display	Warning Generation Conditions
1 Flow Rate	The warning generation and cancellation date/time are displayed appended with a number in order.	The 5-minute average value of the suction flow rate exceeded $\pm 5\%$ of the preset flow rate.
2 Filter dT	The warning generation and cancellation date/time are displayed appended with a number in order.	A difference of at least 5 °C between the ambient temperature and the filter temperature continued for 30 minutes.
3 Sample Time	The sampling time is displayed after sampling stops.	The sampling time exceeded ± 1 hour of the preset time.
4 Power Failure	The warning generation and cancellation date/time are displayed appended with a number in order.	A power failure occurred during sampling.

* "4 Power Failure" is enabled only when "Power Supply" has been set to OFF (sampling is continued after a recovery from a power failure) at "Set Fault Stop" under "Setup."
(⇒ For details, see P37.)

○ Flow Rate (Suction Flow Rate Warning)

When the 5-minute average value of the suction flow rate has exceeded $\pm 5\%$ of the preset flow rate, the date/time that the warning was generated is displayed appended with a number. ▲▼ are displayed when there are more warnings that cannot fit on one screen. The

L a s t		D a t a			
F l o w		R a t e		▼	
W a r n i n g		> + / -		5 %	
1	0 2 / 0 1 / 2 0	1 2 : 2 1			
2	0 2 / 0 1 / 2 0	1 2 : 2 2			
3	0 2 / 0 1 / 2 0	1 2 : 2 3			
4	0 2 / 0 1 / 2 0	1 2 : 2 4			
5	0 2 / 0 1 / 2 0	1 2 : 2 5			

example on the right shows that there are more warnings from the 6th warning onwards.

○ Sample Time (Sampling Time Warning)

When the sampling time has exceeded ± 1 hour of the preset time, the sampling time is displayed after sampling is stopped.

L a s t		D a t a			
S a m p l e		T i m e			
W a r n i n g		> + / -		1 h r	
		2 2 . 5 9			
		h r s			min

○ Power Failure (Power Failure Warning)

When a power failure occurs during sampling, the date/time that the warning was generated is displayed appended with a number.

The example on the right shows that the power failure occurred at 12:21 and that it was recovered at 12:22.

L a s t		D a t a			
P o w e r		F a i l u r e			
W a r n i n g					
1	0 2 / 0 1 / 2 0	1 2 : 2 1			
	0 2 / 0 1 / 2 0	1 2 : 2 2			

2 Current Data (Current Value)

When "2. Current Data" is selected in the main menu, the following sub-menu is displayed. Select the menu in the same way as for the main menu. Press the [MENU/ESCAPE] key several times according to the screen display until the display returns to the main screen.

Current Data Menu Display

Display	Description
1 Ambient BP.	Displays the ambient pressure.
2 Ambient Temp.	Displays the ambient temperature.
3 Filter Temp.	Displays the filter temperature.
4 Filter dT	Difference between the ambient temperature and the filter temperature.

● Ambient BP. (Ambient Pressure)

When "1 Ambient BP." is selected and the [ENTER] key is pressed, the current ambient pressure is displayed.

● Ambient Temp. (Ambient Temperature)

When "2 Ambient Temp." is selected and the [ENTER] key is pressed, the current ambient temperature is displayed.

● Filter Temp. (Filter Temperature)

When "3 Filter Temp." is selected and the [ENTER] key is pressed, the current filter temperature is displayed.

● Filter dT (Filter Temperature Difference)

When "4 Filter dT" is selected and the [ENTER] key is pressed, the current difference between the ambient temperature and the filter temperature is displayed.

(Filter dT) = (Filter Temp.) - (Ambient Temp.)

3 Setup (Settings)

When "3 Setup" is selected in the main menu, the following sub-menu is displayed. Select the menu in the same way as for the main menu. Press the [MENU/ESCAPE] key several times according to the screen display until the display returns to the main screen.

Setup Menu Display

Display	Description
1 Set Flow Rate	Sets the suction flow rate.
2 Set ON Time	Sets the ON timer.
3 Set OFF Time	Sets the OFF timer.
4 Set Date & Time	Sets the clock.
5 Select Timer	Selects the timer.
6 Set Flow Unit	Sets the flow rate unit.
7 Set Fault Stop	Sets the fault stop.

● Setup – Set Flow Rate (Suction Flow Rate Setting)

When "1 Set Flow Rate" is selected and the [ENTER] key is pressed, the preset flow rate is displayed. The setting range for the suction flow rate is 10.0 to 20.0 L/min. The default is 16.7 L/min. When the numerical value is changed by the [UP] and [DOWN] keys and the [ENTER] key is pressed, the newly set value is entered, and the screen returns to the Setup menu.

S e t u p	S e t F l o w R a t e
16.7	L / m i n
A c t u a l V F	

* After setting a new value, if the [MENU/ESCAPE] key is pressed before the [ENTER] key is pressed, the screen will return to the Setup menu without the newly entered value being accepted.

● Setup - Set ON Time (ON Timer Setting)

When "2 Set ON Time" is selected and the [ENTER] key is pressed, the Set ON Time menu is displayed. Select the respective menu by the [UP] and [DOWN] keys, and press the [ENTER] key.

Set ON Time Menu Display

Display	Description
1 Delay Time	Sets the delay time timer.
2 Start Time	Sets the start time timer.

○ Delay Time (Delay Time Timer Setting)

When "1 Delay Time" is selected and the [ENTER] key is pressed, the set value of the sampling start delay time is displayed. The setting range of the delay time is 0.00 to 999.59 (hours.minutes). The default is 0.00.

S e t u p O N T i m e	S e t D e l a y T i m e
24.00	h r s m i n

After the "hours (hrs)" setting is changed by the [UP] and [DOWN] keys and the [ENTER] key is pressed, the "minutes (min)" setting can be changed. Likewise, when the "minutes" setting is changed in the same way as "hours" and the [ENTER] key is pressed, the newly set values are entered. The screen returns to the Set ON Time menu.

* After setting a new value, if the [MENU/ESCAPE] key is pressed before the [ENTER] key is pressed, the screen will return to the Set ON Time menu without the newly entered value being accepted.

○ Start Time (Start Time Timer Setting)

When "2 Start Time" is selected and the [ENTER] key is pressed, the set value of the sampling start time is displayed. The default is "--/--/-- --:--:--" (year/month/day hours:minutes:seconds). After the "year" setting is changed by the [UP] and [DOWN] keys and the [ENTER] key is pressed, the "month" setting can be changed. Likewise, when the "month," "day," and "hours" settings are changed in order in the same way as for "year" and the [ENTER] key is pressed, the newly set values are entered. The screen returns to the Set ON Time menu.

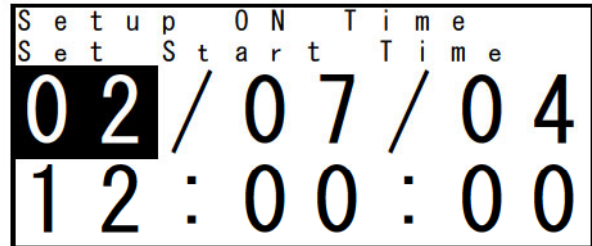

* The setting range for "year" is 02 to 65 (2002 to 2065). The "seconds" setting is fixed at "00." After setting a new "minutes" value, if the [MENU/ESCAPE] key is pressed before the [ENTER] key is pressed, the screen will return to the Set ON Time menu without the newly entered value being accepted.

● Setup – Set OFF Time (OFF Timer Setting)

When "3 Set OFF Time" is selected and the [ENTER] key is pressed, the Set OFF Time menu is displayed. Select the respective menu by the [UP] and [DOWN] keys, and press the [ENTER] key.

Set OFF Time Menu Display

Display	Description
1 Run Time	Sets the run time timer.
2 Stop Time	Sets the stop time timer.
3 Total Volume	Sets the total flow rate timer.

○ Run Time (Run Time Timer Setting)

When "1 Run Time" is selected and the [ENTER] key is pressed, the set value of the sampling time is displayed. The setting range of the sampling time is 0.01 to 999.59 (hours.minutes). The default is 0.01.

After the "hours (hrs)" setting is changed by the [UP] and [DOWN] keys and the [ENTER] key is pressed, the "minutes (min)" setting can be changed. Likewise, when the "minutes" setting is changed in the same way as for "hours" and the [ENTER] key is pressed, the newly set values are entered. The screen returns to the Set OFF Time menu.

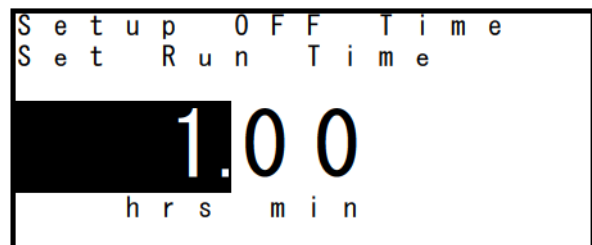

* After setting a new value, if the [MENU/ESCAPE] key is pressed before the [ENTER] key is pressed, the screen will return to the Set OFF Time menu without the newly entered value being accepted.

○ Stop Time (Stop Time Timer Setting)

When "2 Stop Time" is selected and the [ENTER] key is pressed, the set value of the sampling stop time is displayed. The default is "--/--/-- --:--:--" (year/month/day hours:minutes:seconds). After the "year" setting is changed by the [UP] and [DOWN] keys and the [ENTER] key is pressed, the "month" setting can be changed. Likewise, when the "month," "day," and "hours" settings are changed in order in the same way as "year," then the "minutes" setting is changed, and the [ENTER] key is pressed, the newly set values are entered. The screen returns to the Set OFF Time menu.

S	e	t	u	p		O	F	F		T	i	m	e
S	e	t		S	t	o	p		T	i	m	e	
0	2	/	0	7	/	0	4						
1	3	:	0	0	:	0	0						

* The setting range for "year" is 02 to 65 (2002 to 2065). The "seconds" setting is fixed at "00." After setting a new "minutes" value, if the [MENU/ESCAPE] key is pressed before the [ENTER] key is pressed, the screen will return to the Set OFF Time menu without the newly entered value being accepted.

○ Total Volume (Total Flow Rate Timer Setting)

When "3 Total Volume" is selected and the [ENTER] key is pressed, the set value of the total flow rate timer is displayed. The setting range of the total flow rate timer is 0.001 to 999.999 m³. The default is 0.001. After the "integer part (m³ unit)" setting is changed by the [UP] and [DOWN] keys and the [ENTER] key is pressed, the "fractional part (L unit)" setting can be changed. Likewise, when the "fractional part" setting is changed in the same way as "integer part" and the [ENTER] key is pressed, the newly set values are entered. The screen returns to the Set OFF Time menu.

S	e	t	u	p		O	F	F		T	i	m	e		
S	e	t		T	o	t	a	l		V	o	l	u	m	e
5	0	.	0	0	0										
													m ³		
20 °C Standard VF															

* After setting a new value, if the [MENU/ESCAPE] key is pressed before the [ENTER] key is pressed, the screen will return to the Set OFF Time menu without the newly entered value being accepted.

● Setup – Set Date & Time (Clock Setting)

When "4 Set Date & Time" is selected and the [ENTER] key is pressed, the current date and time (year/month/day hours:minutes:seconds) are displayed. After the "year" setting is changed by the [UP] and [DOWN] keys and the [ENTER] key is pressed, the "month" setting can be changed. Likewise, when the "month," "day," and "hours" settings are changed in order in the same way as "year" and the [ENTER] key is pressed, the newly set values are entered. The screen returns to the Setup menu.

S	e	t	u	p											
S	e	t		D	a	t	e		&		T	i	m	e	
0	2	/	0	6	/	0	4								
1	8	:	3	0	:	0	0								

* The setting range for "year" is 02 to 65 (2002 to 2065). The "seconds" setting is fixed at "00." After setting a new "minutes" value, if the [MENU/ESCAPE] key is pressed before the [ENTER] key is pressed, the screen will return to the Setup menu without the newly entered value being accepted.

● Setup – Select Timer (Timer Selection)

When "5 Select Timer" is selected and the [ENTER] key is pressed, the Select Timer menu is displayed as shown on the right. Select the respective menu by the [UP] and [DOWN] keys, and press the [ENTER] key. The 3rd and 4th lines show the type of currently selected ON and OFF timers. In the example on the right, Delay Time is selected for the ON timer and Run Time is selected for the OFF timer.

```
S e t u p
S e l e c t   T i m e r
O N   : D e l a y   T i m e
O F F : R u n   T i m e
1 S e l e c t   O N   T i m e
2 S e l e c t   O F F   T i m e
```

○ Select ON Time (ON Timer Selection)

When "1 Select ON Time" is selected and the [ENTER] key is pressed, the Select ON Time menu is displayed. The default setting is Manual. When an ON timer is selected from among "Manual," "Delay Time," and "Start Time" by pressing the [UP] and [DOWN] keys, and the [ENTER] key is pressed, the selection is determined and the screen returns to the Select Timer menu.

- * After selecting an ON timer in the Select ON Time menu, if the [MENU/ESCAPE] key is pressed before the [ENTER] key is pressed, the screen will return to the Select Timer menu without the newly entered value being accepted.
- * When the ON timer is set to "Manual," data is not logged in chronological order at 1-minute intervals. Also, if a power failure occurs during sampling when performing sampling with the ON timer set to "Manual," all measurement data before the power failure occurred will be lost. (⇒ For details, see P49.)

○ Select OFF Time (OFF Timer Selection)

When "2 Select OFF Time" is selected and the [ENTER] key is pressed, the Select OFF Time menu is displayed. The default setting is Manual. When an OFF timer is selected from among "Manual," "Run Time," "Stop Time," and "Total Volume" by pressing the [UP] and [DOWN] keys, and the [ENTER] key is pressed, the selection is determined and the screen returns to the Select Timer menu.

- * After selecting an OFF timer in the Select OFF Time menu, if the [MENU/ESCAPE] key is pressed before the [ENTER] key is pressed, the screen will return to the Select Timer menu without the newly entered value being accepted.
- * When the OFF timer is set to "Manual" or "Total Volume," data is not logged in chronological order at 1-minute intervals. Also, if a power failure occurs during sampling when performing sampling with the OFF timer set to "Manual" or "Total Volume," all measurement data before the power failure occurred will be lost. (⇒ For details, see P49.)

● Setup – Set Flow Unit (Flow Rate Unit Setting)

When "6 Set Flow Unit" is selected and the [ENTER] key is pressed, the Set Flow Unit menu is displayed. Select the respective menu by the [UP] and [DOWN] keys, and press the [ENTER] key.

Set Flow Unit Menu Display

Display	Description
1 Flow Rate	Sets the suction flow rate unit.
2 Total Volume	Sets the total flow rate unit.
3 Standard Temp.	Sets the standard temperature.

○ Flow Rate (Suction Flow Rate Setting)

When "1 Flow Rate" is selected and the [ENTER] key is pressed, the Flow Rate menu is displayed. The default setting is "Actual VF" (actual flow rate unit). When "Standard VF"(volume flow rate unit after conversion to the standard state) or "Actual VF" is selected for the suction flow rate unit by pressing the [UP] and [DOWN] keys, and the [ENTER] key is pressed, the selection is determined and the screen returns to the Set Flow Unit menu.

* After selecting the suction flow rate unit in the Flow Rate menu, if the [MENU/ESCAPE] key is pressed before the [ENTER] key is pressed, the screen will return to the Set Flow Unit menu without the newly entered value being accepted.

○ Total Volume (Total Flow Rate Setting)

When "2 Total Volume" is selected and the [ENTER] key is pressed, the Total Volume menu is displayed. The default setting is "Actual VF" (actual flow rate unit). When "Standard VF" (volume flow rate unit after conversion to the standard state) or "Actual VF" is selected for the total flow rate unit by pressing the [UP] and [DOWN] keys, and the [ENTER] key is pressed, the selection is determined and the screen returns to the Set Flow Unit menu.

* After selecting the total flow rate unit in the Total Volume menu, if the [MENU/ESCAPE] key is pressed before the [ENTER] key is pressed, the screen will return to the Set Flow Unit menu without the newly entered value being accepted.

○ Standard Temp. (Standard Temperature Setting)

When "3 Standard Temp." is selected and the [ENTER] key is pressed, the screen changes to the Standard Temp. menu, and the current standard temperature set value is displayed. The default setting is 20 °C. When the standard temperature is selected from among 0 °C, 20 °C and 25 °C by pressing the [UP] and [DOWN] keys, and the [ENTER] key is pressed, the selection is determined and the screen returns to the Set Flow Unit menu.

* After selecting the standard temperature in the Standard Temp. menu, if the [MENU/ESCAPE] key is pressed before the [ENTER] key is pressed, the screen will return to the Set Flow Unit menu without the newly entered value being accepted.

● Setup – Set Fault Stop (Fault Stop Setting)

When "7 Set Fault Stop" is selected and the [ENTER] key is pressed, the Set Fault Stop menu is displayed. Select the respective menu by the [UP] and [DOWN] keys, and press the [ENTER] key.

Set Fault Stop Menu Display

Display	Description
1 Power Supply	Sets the power supply fault stop.
2 Flow Rate	Sets the suction flow rate fault stop.

○ Power Supply (Power Supply Fault Stop Setting)

When "1 Power Supply" is selected and the [ENTER] key is pressed, the Power Supply menu is displayed. The default setting is OFF.

When ON is set, sampling will be stopped by the power supply fault if a power failure occurs during sampling or the battery voltage drops to 21 V or less continuously for 30 seconds when the battery is driven by the DC power supply.

When OFF is set, sampling is continued when the power supply is recovered again even if a power failure occurs during sampling. When "ON" or "OFF" is selected for the power supply fault stop setting by pressing the [UP] and [DOWN] keys, and the [ENTER] key is pressed, the selection is determined and the screen returns to the Set Fault Stop menu.

* After selecting the power supply fault stop setting in the Power Supply menu, if the [MENU/ESCAPE] key is pressed before the [ENTER] key is pressed, the screen will return to the Set Fault Stop menu without the newly entered value being accepted.

○ Flow Rate (Suction Flow Rate Fault Stop Setting)

When "2 Flow Rate" is selected and the [ENTER] key is pressed, the Flow Rate menu is displayed. The default setting is ON.

When ON is set, sampling will be stopped by the suction flow rate fault if the instantaneous flow rate display exceeds $\pm 20\%$ of the suction flow rate setting continuously for one minute during sampling.

When OFF is set, sampling will be continued regardless of the instantaneous flow rate display during sampling. When "ON" or "OFF" is selected for the suction flow rate fault stop setting by pressing the [UP] and [DOWN] keys, and the [ENTER] key is pressed, the selection is determined and the screen returns to the Set Fault Stop menu.

* After selecting the suction flow rate fault stop setting in the Flow Rate menu, if the [MENU/ESCAPE] key is pressed before the [ENTER] key is pressed, the screen will return to the Set Fault Stop menu without the newly entered value being accepted.

4 Previous Data (Measurement Value)

When "4 Previous Data" is selected in the main menu display, the file names of all data obtained by past measurements including the latest (previous) measurement data are displayed in chronological order. ▲▼ are displayed when there are more file names that cannot fit on one screen.

P	r	e	v	i	o	u	s	D	a	t	a	
1	:	0	4	0	6	3	0	1	5	1	0	▼
2	:	0	4	0	7	2	0	0	8	2	2	
3	:	0	4	0	8	1	5	0	7	3	0	
4	:	0	4	0	9	3	0	0	9	5	3	
5	:	0	4	1	0	2	0	1	0	0	0	
6	:	0	4	1	1	1	0	1	3	1	0	
7	:	0	4	1	2	0	1	1	6	1	5	

The file names of measurement data show the date/time that sampling was started. The first file name "0406301510" in the above example indicates the file obtained by sampling that started at "2004, June 30, 15 hours 10 minutes." When the measurement data file is selected by pressing the [UP] and [DOWN] keys, and the [ENTER] key is pressed, the measurement data can be checked in the same way as for the Last Data menu. (⇒ For details, see P29.)

Press the [MENU/ESCAPE] key several times according to the screen display until the display returns to the main screen.

- * The maximum number of measurement data files that can be displayed in the Previous Data menu is 99. When sampling is performed with the sampling count exceeding 99, data is not logged in chronological order at 1-minute intervals. When the sampling count has reached 99, clear memory (Clear Logs).

5 Clear Logs (Erase Memory)

When "5 Clear Logs" is selected in the main menu display, the screen on the right is displayed. If the [ENTER] key is pressed in this state, all data obtained by past measurements including the latest measurement data will be cleared from memory.

```
C l e a r   L o g s
P r e s s   [ E N T E R ]   t o
e r a s e   l a s t   a n d
a l l   p r e v i o u s
d a t a .
```

While data is being cleared, "Data erasing" will be displayed for about five seconds. When memory is cleared, "Completed" is displayed and the screen returns to the main menu display.

- * If the [MENU/ESCAPE] key is pressed before the [ENTER] key is pressed in the Clear Logs screen display, the screen will return to the main menu display without memory being cleared. Press the [MENU/ESCAPE] key in the main menu display to return to the main screen.
- * If the [POWER] switch or a key on the panel is operated or the power is turned OFF while data is being cleared (while "Data erasing" is displayed), memory will be damaged, and recording of measurement data might no longer be possible.
- * When memory becomes full of data, data may no longer be logged in chronological order at 1-minute intervals and power may no longer be recovered.
- * Even in the event of a malfunction or other problem, Sibata shall not provide compensation for any data or records that the user failed to obtain or lost, or for any other direct or indirect damage or losses related to that data. Therefore, please periodically back up all data as a precaution in case of a malfunction or accident. It is recommended that functionality be verified in advance and that the instrument be periodically inspected.

6 Test (Device Check)

When "6 Test" is selected in the main menu display, the following Test menu is displayed. Select the menu in the same way as for the main menu. Press the [MENU/ESCAPE] key several times according to the screen display until the display returns to the main screen.

Test Menu Display

Display	Description
1 Total Run Time	Displays the total operating time.
2 Power Supply	Displays the 24 VDC power voltage

● Total Run Time (Total Operating Time)

When "1 Total Run Time" is selected and the [ENTER] key is pressed, the total operating time of the pump is displayed in hour units.

● Power Supply (DC Power Voltage)

When "2 Power Supply" is selected and the [ENTER] key is pressed, the DC power voltage is displayed. When the sampler is run using the 100 VAC power supply, the voltage value (normally, 24 ± 1 V) of the 24 VDC power supply built into the sampler is displayed.

7 Calibration

When "7 Calibration" is selected in the main menu display, the following Calibration menu is displayed. Select the menu in the same way as for the main menu. Press the [MENU/ESCAPE] key several times according to the screen display until the display returns to the main screen.

Calibration Menu Display

Display	Description
1 Flow Rate	Displays the suction flow rate (at calibration).
2 Ambient BP.	Displays ambient pressure calibration (at calibration).
3 Pressure Drop	Displays filter pressure loss (at calibration).
4 Ambient Temp.	Displays the ambient temperature (at calibration).
5 Filter Temp.	Displays the filter temperature (at calibration).

* Calibrate "suction flow rate" after calibrating the "ambient temperature sensor" and "ambient pressure sensor." For the actual volume flow rate (Actual VF), correct the flow rate by "ambient temperature" and "ambient pressure." For this reason, if the "ambient temperature sensor" and "ambient pressure sensor" are calibrated after the "suction flow rate" is calibrated, they will be affected by an error in the "ambient temperature" and "ambient pressure," and the precision of the instantaneous and total flow rates in actual volume flow rate units will not be guaranteed.

● Flow Rate (Suction Flow Rate Calibration)

(1) Connect a "standard flowmeter" to the LV-250R.

(2) When "1 Flow Rate" is selected and the [ENTER] key is pressed, the current standard temperature setting is displayed. The default setting is 20 °C. Select the standard temperature from among 0 °C, 20 °C and 25 °C by pressing the [UP] and [DOWN] keys, and press the [ENTER] key.

```
C a l i b r a t i o n
S t a n d a r d   V F
S e t   S t a n d a r d   T .
                2 0 . 0   ° C
```

(3) Set the flow rate. Press the [UP] and [DOWN] keys to change the numerical value.

```
C a l i b r a t i o n
S t a n d a r d   V F
S e t   S t a n d a r d   T .
                1 6 . 7   L / m i n
```

(4) When the preparation is completed, press the [START/STOP] key to start calibration. "Offset" is displayed on the 3rd line, and the suction pump starts operating. After the pump starts up, "Waiting" is displayed for about one minute for the suction flow rate to stabilize. One minute after the pump has started up, "Start Sample Run" is displayed. Make sure that the instantaneous flow rate display value has stabilized, and note down the readout value on the standard flowmeter. Convert the readout value on the standard flowmeter to the volume flow rate in the standard state according to the standard temperature set in step (2). For example, when 25 °C is selected, obtain the volume flow rate after conversion to 25 °C and 1 atmosphere.

(5) When you have noted down the readout value on the standard flowmeter, press the [START/STOP] key. Pump operation stops, "Adj. Flow Rate" is displayed on the 3rd line, and the average flow rate during pump operation is displayed. Match the flow rate display to the readout value on the standard flowmeter

```
C a l i b r a t i o n
S t a n d a r d   V F
A d j .   F l o w   R a t e
                1 6 . 7   L / m i n
```

by pressing the [UP] and [DOWN] keys. Press the [ENTER] key. Calibration input is accepted, and the screen returns to the Calibration menu.

- * After setting the numerical value, if the [MENU/ESCAPE] key is pressed before the [ENTER] key is pressed, the screen will return to the Calibration menu without the newly entered value being accepted.
- * The average flow rate displayed at (5) is displayed with the adjustment value of the previous calibration reset. For this reason, the average flow rate may differ from the suction flow rate displayed outside of the Calibration menu. Perform error measurement for the suction flow rate in a different menu after calibration.
- * Calibrate "suction flow rate" after calibrating the "ambient temperature sensor" and "ambient pressure sensor." For the actual volume flow rate (Actual VF), correct the flow rate by "ambient temperature" and "ambient pressure." For this reason, if the "ambient temperature sensor" and "ambient pressure sensor" are calibrated after the "suction flow rate" is calibrated, they will be affected by an error in the "ambient temperature" and "ambient pressure," and the precision of the instantaneous and total flow rates in actual volume flow rate units will not be guaranteed.

● **Ambient BP. (Ambient Pressure Sensor Calibration)**

Prepare a standard "ambient pressure gauge."

The ambient pressure measurement port is built in the cooling air exhaust port on the left side of the sampler unit.

When "2 Ambient BP." is selected and the [ENTER] key is pressed, the current ambient pressure is displayed with the adjustment value of the previous calibration reset.

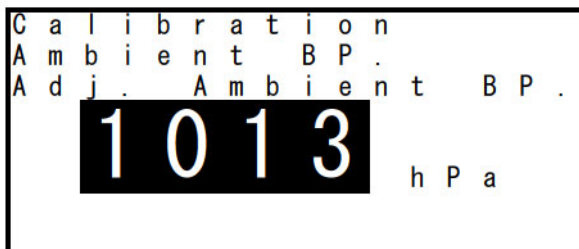

After matching the ambient pressure display to the readout value on the standard pressure gauge by pressing the [UP] and [DOWN] keys, press the [ENTER] key. Calibration input is accepted, and the screen returns to the Calibration menu.

- * After setting the numerical value, if the [MENU/ESCAPE] key is pressed before the [ENTER] key is pressed, the screen will return to the Calibration menu without the newly entered value being accepted.
- * The ambient pressure displayed here is displayed with the adjustment value of the previous calibration reset. For this reason, the ambient pressure may differ from the ambient pressure value displayed outside of the Calibration menu. Perform error measurement for the ambient pressure measurement value in a different menu after calibration.
- * **Calibrate the ambient pressure sensor before measuring the suction flow rate error.** If the ambient pressure sensor is calibrated after the suction flow rate error is measured, the instantaneous and total flow rate measurement values will be affected by the ambient pressure measurement error.

● **Pressure Drop (Filter Pressure Loss Sensor Calibration)**

Prepare a "standard pressure gauge" that is capable of measuring negative pressure (gauge pressure) to a range of 0 to -50 kPa.

Also prepare a hose joint (optionally available) for attachment to the suction port, and a manual vacuum pump (optionally available) for creating suction.

Attach a hose joint to the suction port. As shown in the figure, use the T-shaped adapter and tube to attach a hose joint, standard pressure gauge, and manual vacuum pump. Set the plug valve inside the sampler to the closed position.

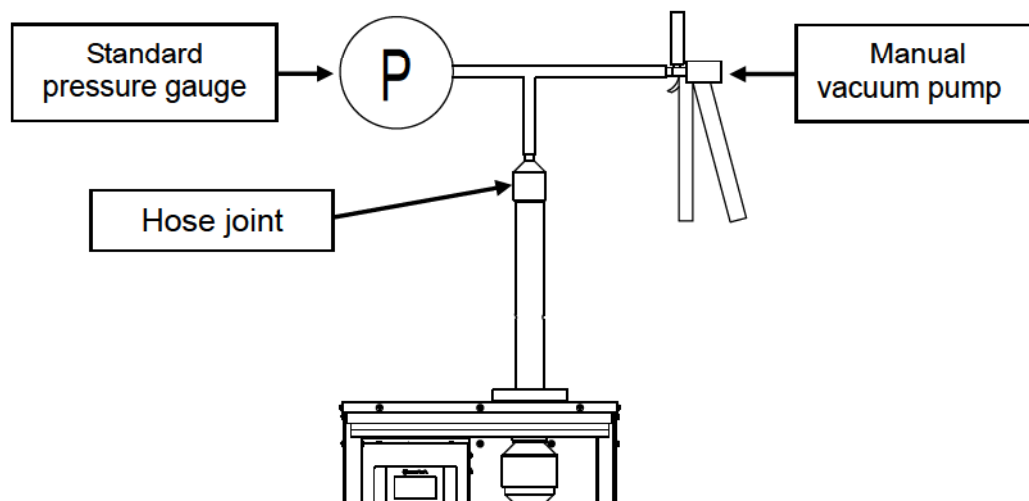

When "3 Pressure Drop" is selected and the [ENTER] key is pressed, the pressure loss is displayed several seconds after "Offset" is displayed with the adjustment value of the previous calibration reset.

The manual vacuum pump gradually decompresses down to -20 kPa.

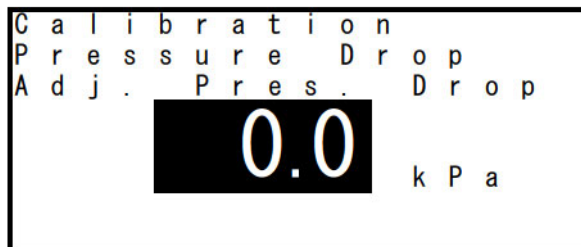

After matching the pressure loss display to the readout value on the standard pressure gauge by pressing the [UP] and [DOWN] keys, press the [ENTER] key. Calibration input is accepted, and the screen returns to the Calibration menu.

After calibration is finished, be sure to set the plug valve inside the sampler to the closed position.

- * When altering the pressure by the manual vacuum pump, do not decompress "more than -50 kPa" or pressurize (apply a positive pressure) by mistake. Doing so might cause the built-in pressure sensor to malfunction.
- * After setting the numerical value, if the [MENU/ESCAPE] key is pressed before the [ENTER] key is pressed, the screen will return to the Calibration menu without the newly entered value being accepted.
- * The initially displayed pressure loss is displayed with the adjustment value of the previous calibration reset. For this reason, the pressure loss may differ from the pressure loss value displayed outside of the Calibration menu. Perform error measurement for the filter pressure loss in a different menu after calibration.

● Ambient Temp (Ambient Temperature Sensor Calibration)

Prepare a "standard thermometer." Bring the standard thermometer close to the ambient temperature sensor.

When "4 Ambient Temp." is selected and the [ENTER] key is pressed, the current ambient temperature is displayed with the adjustment value of the previous calibration reset.

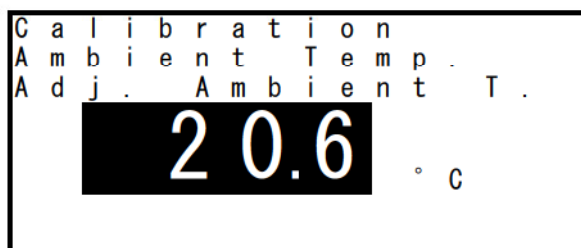

After matching the ambient temperature display to the readout value on the standard thermometer by pressing the [UP] and [DOWN] keys, press the [ENTER] key. Calibration input is accepted, and the screen returns to the Calibration menu.

- * After setting the numerical value, if the [MENU/ESCAPE] key is pressed before the [ENTER] key is pressed, the screen will return to the Calibration menu without the newly entered value being accepted.
- * The initially displayed ambient temperature is displayed with the adjustment value of the previous calibration reset. For this reason, the ambient temperature may differ from the ambient temperature value displayed outside of the Calibration menu. Perform error measurement for the ambient temperature in a different menu after calibration.
- * **Calibrate the ambient temperature sensor before measuring the suction flow rate error.** If the ambient temperature sensor is calibrated after the suction flow rate error is measured, the instantaneous and total flow rate measurement values will be affected by the ambient temperature measurement error.

● Filter Temp. (Filter Temperature Sensor Calibration)

Prepare a "standard thermometer." Place the standard thermometer near the temperature sensor in the filter holder support lower section. Select "5 Filter Temp." and press the [ENTER] key. Then calibrate the filter temperature sensor in the same way as for calibrating the ambient temperature sensor mentioned above.

Sampling Start Stanby

Main Screen

[1] Waiting Time Remaining (Remaining Time Until Sampling Start)

The time until sampling starts after the pump started up is displayed.

When "OVER" is displayed on the 3rd line, this indicates that the time has exceeded 999 hours and 59 minutes.



[2] Waiting Set ON Time (ON Timer Set Value)

Either of the ON timers - Delay Time and Start Time - preset at "Select Timer" is displayed. The figure on the right is a display example when "Start Time" is selected.

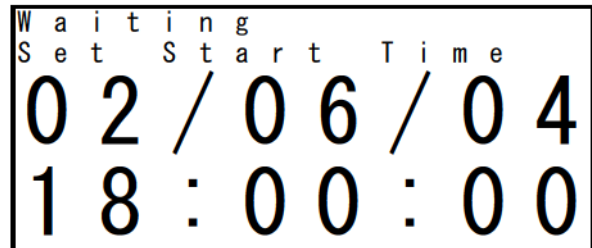

Main Menu

3 Setup (Setting)

When "3 Setup" is selected in the main menu, the following sub-menu is displayed. Select the menu in the same way as for the main menu. Press the [MENU/ESCAPE] key several times according to the screen display until the display returns to the main screen.

Setup Menu Display

Display	Description
1 Set Flow Rate	Displays the present flow rate.
2 Set ON Time	Sets the ON timer.
3 Set OFF Time	Sets the OFF timer.

● Set Flow Rate (Auction Flow Rare Set Value)

When "1 Set Flow Rate" is selected and the [ENTER] key is pressed, the preset flow rate is displayed.

● Set ON Time (ON Timer Set Value)

When "2 Set ON Time" is selected and the [ENTER] key is pressed, either of the ON timers - Delay Time and Start Time - preset at "Select Timer" is displayed.

● Set OFF Time (OFF Timer Set Value)

When "3 Set OFF Time" is selected and the [ENTER] key is pressed, one of the OFF timers - Run Time, Stop Time and Total Volume - preset at "Select Timer" is displayed.

During Sampling

Main Screen

[1] Sampling Live Flow Rate (Instantaneous Flow Rate)

The instantaneous flow rate of the pump is displayed. On the last line, for the actual volume flow rate, "Actual VF" is displayed, and for the volume flow rate after conversion to the standard state, the standard temperature and "Standard VF" are displayed. (⇒ For details, see P36.)

[2] Sampling Total Volume (Total Flow Rate)

The total flow rate since sampling was started is displayed. On the last line, for the actual volume flow rate, "Actual VF" is displayed, and for the volume flow rate after conversion to the standard state, the standard temperature and "Standard VF" are displayed. (⇒ For details, see P36.)

[3] Sampling Total Samp. Time (Sampling Time)

The time elapsed since sampling was started is displayed. When "OVER" is displayed on the 3rd line, this indicates that the time has exceeded 999 hours and 59 minutes.

[4] Sampling Time Remaining (Remaining Sampling Time)

The time remaining until sampling is stopped is displayed. When Total Volume is selected as the OFF timer, the total flow rate value is displayed. When Manual is selected, "----.----" is displayed.

[5] Current Date and Time (Current Date/Time)

The current date/time is displayed in the format year/month/day hours:minutes. The year and time are displayed by the lower two digits of the calendar year and in 24-hour units, respectively.

Main Menu

2 Current Data (Current Value)

When "2 Current Data" is selected in the main menu, the following sub-menu is displayed. Select the menu in the same way as for the main menu. Press the [MENU/ESCAPE] key several times according to the screen display until the display returns to the main screen.

Current Data Menu Display

Display	Description
1 Total Volume	Displays the total flow rate.
2 Flow Rate	Displays the suction flow rate (average, fluctuation coefficient).
3 Sample Time	Displays the sampling start date/time.
4 Ambient BP.	Displays the ambient pressure (minimum, maximum, 30-second average).
5 Pressure Drop	Displays the filter pressure loss (minimum, maximum, 30-second average).
6 Temperature	Displays the ambient temperature (minimum, maximum, 30-second average), the filter temperature (minimum, maximum, 30-second average, maximum temperature difference from ambient temperature, time and date when the maximum temperature difference from ambient temperature occurred).
7 Warning	Displays the warning (flow rate fault, filter temperature fault, sampling time fault, power failure).

* Each of the measurement values for "suction flow rate," "ambient pressure," "pressure loss," and "temperature" is displayed 30 seconds after sampling is started and their values are updated at 30-second intervals. "0" (zero) is indicated for each of these measurement values until 30 seconds has elapsed since sampling was started.

● Total Volume (Total Flow Rate)

When "1 Total Volume" is selected and the [ENTER] key is pressed, the total flow rate is displayed. On the last line, for the actual volume flow rate, "Actual VF" is displayed, and for the volume flow rate after conversion to the standard state, the standard temperature and "Standard VF" are displayed. (⇒ For details, see P36.)

● Flow Rate (Suction Flow Rate)

When "2 Flow Rate" is selected and the [ENTER] key is pressed, the Flow Rate menu is displayed. When "AVG." is selected by the [UP] and [DOWN] keys and the [ENTER] key is pressed, the average flow rate since sampling was started is displayed. Likewise, when "CV." is selected and the [ENTER] key is pressed, the fluctuation coefficient of the suction flow rate since sampling was started is displayed.

● Sample Time (Sampling Time)

When "3 Sample Time" is selected and the [ENTER] key is pressed, "1 Start" is displayed. When the [ENTER] key is pressed again, the date/time when sampling was started is displayed.

● Ambient BP. (Ambient Pressure)

When "4 Ambient BP." is selected and the [ENTER] key is pressed, the Ambient BP. menu is displayed. When "MIN.," "MAX.," and "30sec AVG." are respectively selected by the [UP] and [DOWN] keys and the [ENTER] key is pressed, the respective ambient pressure minimum value, maximum value and 30-second average value since sampling was started are displayed.

● **Pressure Drop (Filter Pressure Loss)**

When "5 Pressure Drop" is selected and the [ENTER] key is pressed, the Pressure Drop menu is displayed. When "MIN.," "MAX.," and "30sec AVG." are respectively selected by the [UP] and [DOWN] keys and the [ENTER] key is pressed, the respective filter pressure loss minimum value, maximum value and 30-second average value since sampling was started are displayed.

● **Temperature**

When "6 Temperature" is selected and the [ENTER] key is pressed, Temperature menu is displayed. When "1 Ambient" (ambient temperature) is selected by the [UP] and [DOWN] keys and the [ENTER] key is pressed, the Ambient Temp. menu is displayed.

When "MIN.," "MAX.," and "30sec AVG." are respectively selected by the [UP] and [DOWN] keys and the [ENTER] key is pressed, the respective ambient temperature minimum value, maximum value and 30-second average value since sampling was started are displayed.

● **Filter Temp. (Filter Temperature)**

When "6 Temperature" is selected and the [ENTER] key is pressed, the Temperature menu is displayed. When "2 Filter" is selected by the [UP] and [DOWN] keys and the [ENTER] key is pressed, the Filter Temp. menu is displayed. When "MIN.," "MAX.," and "30sec AVG" are respectively selected by the [UP] and [DOWN] keys and the [ENTER] key is pressed, the respective filter temperature minimum value, maximum value and 30-second average value since sampling was started are displayed. When "MAX. dT" and "MAX. dT Time" are selected and the [ENTER] key is pressed, the maximum temperature difference between the ambient temperature and the filter temperature, and the date and time at which this maximum temperature difference occurred are displayed. Difference between the ambient temperature and the filter temperature (Filter dT) = (Filter Temp.) – (Ambient Temp.)

● **Warning**

When "7 Warning" is selected and the [ENTER] key is pressed, the Warning menu is displayed. When "Flow Rate," "Sample Time," and "Power Failure" are respectively selected by the [UP] and [DOWN] keys and the [ENTER] key is pressed, the respective warning information is displayed. The display details are the same as those for Warning for the Last Data menu. (⇒ For details, see P30.)

Warning Menu Display

Warning Display		Warning Generation Conditions
1 Flow Rate	The warning generation and cancellation date/time are displayed appended with a number in order.	The 5-minute average value of the suction flow rate exceeded ±5 % of the preset flow rate.
2 Filter dT	The warning generation and cancellation date/time are displayed appended with a number in order.	A difference of at least 5 °C between the ambient temperature and the filter temperature continued for 30 minutes.
3 Sample Time	The sampling time is displayed after sampling stops.	The sampling time exceeded ±1 hour of the preset time.
4 Power Failure	The warning generation and cancellation date/time are displayed appended with a number in order.	A power failure occurred during sampling.

* "4 Power Failure" is enabled only when "Power Supply" has been set to OFF (sampling is continued after a recovery from a power failure) at "Set Fault Stop" under "Setup." (⇒ For details, see P37.)

3 Setup (Settings)

When "3 Setup" is selected in the main menu, the following sub-menu is displayed. Select the menu in the same way as for the main menu. Press the [MENU/ESCAPE] key several times according to the screen display until the display returns to the main screen. How each of the screens are viewed is the same as "Setup" before sampling is started. (⇒ For details, see P32.)

Setup Menu Display

Display	Description
1 Set Flow Rate	Displays the present flow rate.
2 Set ON Time	Sets the ON timer.
3 Set OFF Time	Sets the OFF timer.

● Set Flow Rate (Suction Flow Rate Set Value)

When "1 Set Flow Rate" is selected and the [ENTER] key is pressed, the preset flow rate is displayed.

● Set ON Time (ON Timer Set Value)

When "2 Set ON Time" is selected and the [ENTER] key is pressed, one of the ON timers - Manual, Delay Time and Start Time - preset at "Select Timer" is displayed.

● Set OFF Time (OFF Timer Set Value)

When "3 Set OFF Time" is selected and the [ENTER] key is pressed, one of the OFF timers - Manual, Run Time, Stop Time and Total Volume - preset at "Select Timer" is displayed.

After Sampling is Stopped

Sampling is stopped either by the preset timer time being reached or by pressing the [START/STOP] key. When sampling ends normally, "Finished Memorizing" is displayed, followed by "Finished...Memory Time Remaining : ###hrs." ("#" stands for a number.) "Memory Time Remaining : ###hrs" is the remaining memory time in which data can be logged. The maximum data logger time is 133 hours (about 5 days). Also, the maximum sampling count is 99. When the remaining memory time has fallen below one hour, or the sampling count has reached 99, clear memory (Clear Logs).
(⇒ For details, see P38.)

```

F i n i s h e d
P r e s s [ D O W N ] t o
d i s p l a y " T o t a l
V o l u m e " .
M e m o r y T i m e
R e m a i n i n g : 1 3 3 h r s
    
```

* To perform sampling longer than the remaining memory time of the data logger or to perform sampling with the sampling count exceeding 99, data is not logged in chronological order at 1-minute intervals.

When "Finished..." is displayed, press the [DOWN] key. The total flow rate during sampling is displayed.

Sampling Fault

When sampling does not end normally, "FAULT" is displayed on the 2nd line, and the cause of the fault stop is displayed on the 3rd line. In the example on the right, "Pressure Drop" (pressure loss fault) is displayed.

When a fault stop has occurred, data up to the point when the fault stop occurred is recorded.

Note, however, that when a power voltage fault has caused the stop, all data may be lost depending on the timer setting.

(⇒ For details, see P49.)

```

F i n i s h e d
F A U L T
P r e s s u r e D r o p
P r e s s [ D O W N ] t o
d i s p l a y " T o t a l
V o l u m e " .
M e m o r y T i m e
R e m a i n i n g : 1 2 9 h r s
    
```

List of Fault Stop Items

Displayed Message	Fault Stop Cause	
Pressure Drop	Pressure loss fault:	A pressure loss of 40 kPa or more continued for 30 seconds.
Ambient Temp.	Ambient temperature fault:	An ambient temperature of 45 °C or higher continued for 30 seconds.
Flow Rate	Suction flow rate fault:	An error of ±20 % or more of the set value continued for one minute.
Power Low Vol.	Power voltage fault:	A power failure occurred or a DC voltage of 21 V or less continued for 30 seconds.

Data Logging

The measurement results of data logged in chronological order at 1-minute intervals (total flow rate, average flow rate, fluctuation coefficient, ambient pressure, pressure loss, ambient temperature, generation of warning) can be checked by using the LV-250/40B communications cable (optionally available) provided with the software. Note, however, that data logged in chronological order at 1-minute intervals may or may not be logged according to the ON/OFF timer settings.

* As the average flow rate and fluctuation coefficient (flow rate) measurement values, the values calculated up to respective times from since pump operation was started are recorded. Also, for measurement values other than warnings, 1-minute interval average values are recorded.

ON Timer Setting

ON Timer	Data is logged in chronological order at 1-minute intervals.
Manual	No
Delay Time	Yes
Start Time	Yes

OFF Timer Setting

OFF Timer	Data is logged in chronological order at 1-minute intervals.
Manual	No
Run Time	Yes
Stop Time	Yes
Total Volume	No

The maximum data logger time is 133 hours. Also, the maximum sampling count is 99. When the remaining memory time that is displayed after sampling is stopped has fallen below one hour, or the number of files displayed in the Previous Data menu has reached 99, clear memory (Clear Logs). (⇒ For details, see P38.)

* Data that can be checked by Last Data in the main menu is saved. Note, however, that this is not necessarily so in the case of a power fault. (⇒ For details, see P50)

Power Failure Processing

When a power failure occurs while the pump is running by a 100VAC power supply, or the battery voltage drops while the pump is running by the DC power supply, the following processing is executed according to the power supply fault stop setting. The power supply fault stop setting is set to ON by default. When the pump is being driven by the DC power supply, set the power supply fault stop setting to ON.

● Sampling Start Standby (While ON Timer is Running)

Processing When a Power Failure Occurs During Pump Operation by 100VAC Power

Power Supply Fault Stop Setting	ON Timer Selection
	Delay Time / Start Time
ON (Default setting)	After a recovery from a power failure, the power voltage fault is displayed and pump operation is discontinued.
OFF	<ul style="list-style-type: none"> • When the power failure is recovered before the sampling start time, pump operation is continued. • When the power failure is recovered after the sampling start time has been exceeded, an ON timer setting error is displayed and pump operation is discontinued.

* The sampling start timer for the Delay Time setting is the time obtained by adding the Delay Time set time to the time when the [START/STOP] key is pressed (i.e. the time when the ON timer is started).

When the Battery Voltage Has Dropped to 21 V or Less During Operation by DC power supply (Sold Separately)

Power Supply Fault Stop Setting	ON Timer Selection
	Delay Time / Start Time
ON (Default setting)	The power voltage fault is displayed and pump operation is discontinued.
OFF	Pump operation is continued even if the battery voltage drops. There is the risk that the DC power supply might overdischarge. So, when the pump is being driven by the DC power supply, set the power supply fault stop setting to ON.

● During Sampling

Processing When a Power Failure Occurs During Pump Operation by 100VAC Power

Power Supply Fault Stop Setting	OFF Timer Selction			
	Manual	Run Time	Stop Time	Total Volume
ON	After a recovery from a power failure, the power voltage fault is displayed and pump operation is discontinued. All data before the power failure occurred will be lost.	After a recovery from a power failure, the power voltage fault is displayed and pump operation is discontinued. Data before the power failure occurred will be saved .	After a recovery from a power failure, the power voltage fault is displayed and pump operation is discontinued. Data before the power failure occurred will be saved .	After a recovery from a power failure, the power voltage fault is displayed and pump operation is discontinued. All data before the power failure occurred will be lost.
	* When the ON timer is set to "Manual," after a recovery from a power failure, the power voltage fault is displayed and pump operation is discontinued. Also, all data before the power failure occurred will be lost.			
OFF (Default setting)	After a recovery from a power failure, pump operation is continued. However, all data before the power failure occurred will be lost.	After a recovery from a power failure, pump operation is continued until the remaining sampling time reaches 0 (zero). Also, the data before the power failure occurred will be saved .	When the power failure is recovered before the sampling stop time, pump operation is continued. When the power failure is recovered after the sampling stop time has been exceeded, an OFF timer setting error is displayed and pump operation is discontinued. In both cases, the data before the power failure occurred will be saved .	After a recovery from a power failure, pump operation is continued until the total flow rate reaches the set value. However, all data before the power failure occurred will be lost.
	* When the ON timer is set to "Manual," after a recovery from a power failure, the pump returns to the sampling start state and sampling is repeated from the beginning. Also, all data before the power failure occurred will be lost.			

* If a power failure occurs during sampling with a data logger memory error still displayed, all measurement data before the power failure occurred will be lost after a recovery from a power failure regardless of the power supply fault stop setting. Also, the preset flow rate is displayed without the power voltage fault being displayed.

When the Battery Voltage Has Dropped to 21 V or Less During Operation by DC power supply

Power Supply Fault Stop Setting	OFF Timer Selection			
	Manual	Run Time	Stop Time	Total Volume
ON (default setting)	The power voltage fault is displayed and pump operation is discontinued. Data before the stop will be saved .	The power voltage fault is displayed and pump operation is discontinued. Data before the stop will be saved .	The power voltage fault is displayed and pump operation is discontinued. Data before the stop will be saved .	The power voltage fault is displayed and pump operation is discontinued. Data before the stop will be saved .
OFF	Pump operation is continued even if the battery voltage drops.	Even if the battery voltage drops, pump operation is continued until the remaining sampling time reaches 0 (zero).	Even if the battery voltage drops, pump operation is continued until the sampling stop time is reached.	Even if the battery voltage drops, pump operation is continued until the total flow rate reaches the set value.

* There is the risk that the DC power supply might overdischarge. So, when the pump is being driven by the DC power supply, set the power supply fault stop setting to ON.

Fault Stop Function

When a fault listed below occurs during sampling, the fault stop cause is displayed and sampling is discontinued. Fault stop "enabling/disabling" can be set to "suction flow rate fault" and "power voltage fault" in the fault stop settings. When a fault stop has occurred, data up to the point when the fault stop occurred is recorded. Note, however, that when a power voltage fault has caused the stop, all data may be lost depending on the timer setting.

List of Fault Stop Items

Displayed Message	Fault Stop Cause	
Pressure Drop	Pressure loss fault:	A pressure loss of 40 kPa or more continued for 30 seconds.
Ambient Temp.	Ambient temperature fault:	An ambient temperature of 45 °C or higher continued for 30 seconds.
Flow Rate	Suction flow rate fault:	An error of ± 20 % or more of the set value continued for one minute.
Power Low Vol.	Power voltage fault:	A power failure occurred or a DC power supply voltage of 21 V or less continued for 30 seconds.

Maintenance

Periodic maintenance is required in order to extend the life of this product.

When cleaning the product, use dry cloths and thoroughly wrung out damp cloths.

In the following cases, repairs or maintenance must be performed by the manufacturer.

Contact your Sibata agent.

1. One year has elapsed since flow rate calibration by the manufacturer.
2. The pump operating time has exceeded 5,000 hours.
3. The packing or rubber parts have become stiff, or cracks have developed.

If any other problems arise, contact your Sibata agent.

Troubleshooting

Inspect the pump again before submitting it for repair. If this does not solve the problem, contact your Sibata agent.

Symptom	Reason	Remedy
No display.	BATTERY LOW is blinking.	Check the DC power supply battery.
	The power cord is disconnected from the main unit.	Connect the power cord to the main unit, and insert the power plug into the power outlet.
The pump does not start up.	The settings are wrong.	Make sure that the settings are correct.
	The housing is hot.	Turn the power OFF, and wait for the housing to cool down. If this does not remedy the problem, contact your Sibata agent.
Keys cannot be pressed.	KEY LOCK is lit.	Turn the [POWER] switch to the ON position.
The flow rate does not decrease.	The plug valve has closed.	Open the plug valve.
	The inside of the piping between the sample air inlet port and the filter holder has become dirty and clogged.	Check the inside of the piping. If it is clogged, clean it.
	There is a leak between the PM10 impactor and the filter holder.	Connect each part carefully, and check that there are no leaks.
	The backup filter is dirty.	Replace filter element of the backup filter.
An abnormal ambient temperature value is indicated.	The connector for the ambient temperature sensor is not connected correctly.	Insert the connector for the ambient temperature sensor all the way in until you hear a click.
The clock is out of order. Logging is impossible.	The internal battery is dead.	The battery must be replaced. Contact your Sibata agent.
"ERROR Set Start Time" is displayed when the [START/STOP] key is pressed.	Invalid ON timer setting.	Set the ON timer setting again.
"ERROR Set Stop Time" is displayed when the [START/STOP] key is pressed.	Invalid OFF timer setting.	Set the OFF timer setting again.
"ERROR Memory Insufficient" is displayed when the [START/STOP] key is pressed.	Insufficient data logger memory.	Clear memory.
"ERROR Memory Insufficient" is displayed even after executing Clear Logs.	The total sampling time is set to 130 hours or more.	Set the OFF timers Run Time and Stop Time so that the total sampling time is less than 130 hours.
Sampling is canceled before the OFF timer preset time is reached and "FAULT" and the following faulty type are displayed: 1: Pressure Drop 2: Ambient Temp. 3: Flow Rate 4: Power Low Vol.	1: Filter pressure loss fault 2: Ambient temperature fault 3: Suction flow rate fault 4: Power voltage fault	Remove the cause of the fault stop, and retry operation.

Main Specifications

Item Code	080040-710	
Model	LV-250R	
Particle Separation Classification	PM2.5 (Cut 50 % of 2.5 μm particles)	
Suction Flow Rate	16.7 L/min (10.0 to 20.0 L/min controllable)	
Instantaneous Flow Rate Display Range	5.0 to 50.0 L/min	
Constant Flow Rate Operating Range	16.7 L/min: 0 to 30 kPa	
Total Flow Rate Display Range	0.000 to 999.999 m^3	
Display Range of Set Time	0.00 to 999.59 (hours.minutes)	
Time Setting/Display	YY/MM/DD hh:mm:ss (year/month/day hour:minute:second)	
Ambient Pressure Display Range	800 to 1100 hPa	
Pressure Loss Display Range	0.0 to 50.0 kPa	
Temperature Display Range	-10.0 to 50.0 $^{\circ}\text{C}$	
Filter	47mm dia. (PTFE, quartz fiber)	
Built-In Flow Meter	Mass-flow sensor	
Sampling Start (ON) Timer	Manual	This is used to manually operate the pump. (Data is not logged in chronological order at 1-minute intervals.)
	Delay Time	This is the delay time timer. This is used to start sampling after the preset time has elapsed.
	Start Time	This is the start time timer. This is used to start sampling at the preset time.
Sampling Stop (OFF) Timer	Manual	This is used to manually operate the pump. (Data is not logged in chronological order at 1-minute intervals.)
	Run Time	This is the run time timer. This is used to stop sampling after the preset time has elapsed.
	Stop Time	This is the stop time timer. This is used to stop sampling at the preset time.
	Total Volume	Total flow rate timer. This is used to stop sampling when the preset total flow rate value is reached. (Data is not logged in chronological order at 1-minute intervals.)
Thermometer	Thermistor	
Pressure Gauge	Semiconductor sensor	
Suction Pump	Diaphragm pump	
Display	Liquid crystal display	
Display Item	Flow rate (instantaneous, average, fluctuation coefficient, total), ambient temperature, ambient pressure, filter temperature, filter pressure loss, date, time, fault occurrence	
Output	RS-232C (optional)	
Data Logger Time	Approx. 5 days max. (Sampling count: Up to 99)	
Operating Temperature / Humidity Range	0 to 40 $^{\circ}\text{C}$ 10 to 90 % rh (no condensation)	
Power Supply	100 VAC, 50/60 Hz, 2 A, 24 VDC (optional)	
Dimensions (main unit)	400 W \times 320 D \times 1414 H mm, Sampling height 2 m or 3 m	
Weight	Approx. 15 kg (main unit), Approx. 12 kg (stand)	
Material	Main unit case: Aluminum Stand: SUS304, Aluminum Filter holder: POM, SUS304 Filter holder support: Aluminum	
Accessories	PM10 impactor 1, PM2.5 impactor 1 Filter holder 1, 2 A fuse 1	

Options and Consumables

Item Code	Product Name
080040-7001	Communication cable with software for LV-250/LV-40B
080040-7002	PM2.5 sampling filters, 47 mm dia., for mass spectrometry (50 pcs.)
080040-7003	PM2.5 filter holder
080180-2505	PM2.5 impactor filter, 37 mm dia. (100 pcs.)
-	Sampling pipe 1 m
-	Sampling pipe joint
080180-2525	Hose joint
080860-001	VFE-3 Filter elements (5 pcs.)
080870-10	Manual vacuum pump

Warranty and Repair

This product shall be repaired free-of-charge should it malfunction within one year of purchase. When asking for repair, be sure to directly contact the dealer of purchase. Consumables provided with this product fall outside of the scope of this warranty. Repair of the product itself also shall fall outside of the scope of this warranty if any of the following causes it to malfunction:

- Faults or damage resulting from incorrect use
- Faults or damage resulting from repairs or modifications implemented by parties other than Sibata
- Faults or damage resulting from fires or natural disasters, such as earthquakes
- Faults or damage resulting from salt or gas damage, or from abnormal voltage
- Faults or damage occurring after purchase due to relocation, movement, falling, or vibration
- Faults or damage resulting from the use of consumable items not specified by Sibata
- Modifications and repairs prohibited. Never disassemble or modify this product, as the warranty will be voided. Such actions may cause unexpected faults or accidents.

Disclaimer

Should some nonconformity occur during use of this product, Sibata does not assume any liability whatsoever for compensation of data or content that could not be acquired or logged as a result, loss of data or other content, and other direct and indirect damages (loss of business profit, interruption of business, etc.) relating to the preceding.

Sibata guarantees repair of production malfunctions under fixed conditions. However, Sibata does not offer any compensation for loss of or damage to data stored on the product. When asking Sibata for repair or other services, make a backup of any required data. Sibata does not assume any liability whatsoever for any damages that may occur accompanying loss or discarding of data due to infringement of precautions described in this manual or neglect to back up data on the part of the customer.

For details of repair after the Warranty has expired, contact your Sibata agent. The product shall be repaired for a fee only if Sibata judges that repair shall restore its functions, and its functions can be sustained in the future only in accordance with specified methods of use.

When returning this product for repair, fill in the Trouble Notification Sheet and send this sheet together with this product. (See page 59.)

Disposal of the Product

Dispose of the product in accordance with the disposal laws and regulations of your respective local governing body. The sampler body is made almost entirely from metals (aluminum and stainless steel).

Inquiries

If you have any questions about this product, or if there is any other way in which we can be of assistance, contact your Sibata agent.

19.04.18K (05)

Trouble Notification Sheet

This sheet is to be filled with information required for the smooth checking and repair of malfunctions. Please fill in this sheet in as much detail as possible. Also, attach this sheet when asking for repair.

PM2.5 Sampler LV-250R Trouble Notification Sheet

If the sampler malfunctions, make a copy of this sheet, fill it in and contact your Sibata agent.

Entry Date (y/m/d):

Product Conditions of Use

Model: : LV-250R

Serial No.: _____ Date of Purchase (y/m/d): _____

Start of Use (y/m/d): _____

Frequency of Use: : Every day : __ days/week : __ days/month

Number of Hours Used per Day: _____

Operating Environment Temperature (measured temperature, if possible): () °C to () °C

Number of Installed Units: __ units Application: _____

Symptoms of Malfunction

Frequency of Occurrence: : Every time : Occasionally : Rarely : Other (_____)

Start of Malfunction: : Since purchase : Within a month : Within a week : Other (_____)

Symptoms: (Write in as much detail as possible.) Ex: Backlight does not turn ON even by pressing a key.

Check Items (Please choose your answer.)

- Does the LCD display turn ON when the power to the sampler is turned ON? (Yes · No)
- Is it dirty inside the unit (including the sampling line and the backup filter)? (Yes · No)
- Has it been used near the sea or a hot spring? (Yes · No)
- Are there any signs or scratches on the sampler body indicating that it has been dropped or impacted? (Yes · No)

Work Check Items When Asking for Repair

- : Make a copy of the Trouble Notification Sheet, fill it in and send it together with the sampler.
- : If there is the risk that harmful substances have been sucked into the sampler, put this Trouble Notification Sheet in an envelope, and stick this to the outside of the box. Also, be sure to clearly indicate the presence of such substances on the Trouble Notification Sheet.



DISTRIBUTED BY:

Sedulitas

PEOPLE | PASSION | PRECISION

info@sedulitas.co.za +27 (0)82 551 4001

www.sedulitas.co.za

SIBATA SCIENTIFIC TECHNOLOGY LTD.



1-1-62, Nakane, Soka, Saitama, 340-0005, Japan

TEL:+81-48-933-1582 FAX:+81-48-933-1591

E-mail:overseas@sibata.co.jp

<http://www.sibata.co.jp/english/>

Note) Shape, dimensions, specifications, and other product information are subject to change without notice in the interest of product improvement to the extent that product functions and applications will not be impaired.