

DATA SHEET

# PITOT TUBE

## NPL type (L / straight)



Large range of type L Pitot tubes



High quality and accuracy



Better than 1% for an alignment in relation to the flow axis of the fluid of  $\pm 10^\circ$



Made according to AFNOR NF ISO 3966



Sauermann offers a broad range of **Pitot tubes** of great quality and accuracy realised according to the NF ISO 3966 norm.

The Sauermann **Pitot tubes**, connected to a differential column of liquid manometer, with needle or electronic, enable to measure the dynamic pression of a fluid in movement in a pipe and determine its speed in m/s and its flow in m<sup>3</sup>/h.

The **Pitot tubes** are used in climatic engineering, ventilation, dust-removal and pneumatic transport. They are particularly adapted for measurement in warm air, charged with particles and for high speed.

## References

### Reference

### Description

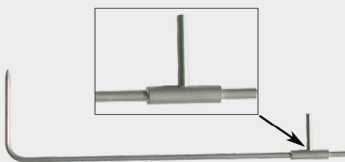

Pitot tube L type

Pitot tubes with ellipsoidal top.  
A total pressure port and six holes of static pressure.  
Body in full stainless steel.

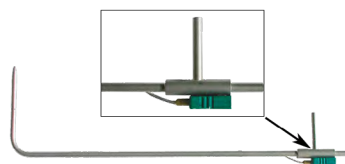

Pitot tube L type with K thermocouple

Pitot tubes with ellipsoidal top.  
A total pressure port and six holes of static pressure.  
K thermocouple probe lined integrated with connecting cable of 1.5 meter long.  
Body in full stainless steel.



Pitot tube straight type & straight type with K thermocouple

It enables to carry out measurement directly by immersing the tube in the air-diffusing equipment.  
Diameter and dimensions: same as the NPL curved Pitot.

## Technical features

Model	AFNOR NF
Coefficient	1.0015 ±0.01
Material	Inox 316 L
Measuring range	3 to 85 m/s
Operating temperature	From 0 to 600°C in standard and up to 1000°C in option
Static pressure	2 bar maximum in static Hereafter on request
Global accuracy of the measurement system	Better than 1% for an alignment in relation to the flow axis of the fluid of ±10°
Standards	NF ISO 3966

## Presentation of the range

### • Pitot tubes L type and straight type

Diameter	Reference L type	Reference straight type	Length
Ø3 mm	TPL-03-100	TPL-D-03-100	100 mm
	TPL-03-200	TPL-D-03-200	200 mm
	TPL-03-300	TPL-D-03-300	300 mm
Ø6 mm	TPL-06-300	TPL-D-06-300	300mm
	TPL-06-500	TPL-D-06-500	500 mm
	TPL-06-800	TPL-D-06-800	800 mm
Ø8 mm	TPL-08-1000	TPL-D-08-1000	1000 mm
	TPL-08-1250	TPL-D-08-1250	1250 mm
Ø12 mm	TPL-12-1500	TPL-D-12-1500	1500 mm
	TPL-12-2000	TPL-D-12-2000	2000 mm
Ø14 mm	TPL-14-2500	-	2500 mm
	TPL-14-3000	TPL-D-14-3000	3000 mm

### • Pitot tubes L type and straight type with K thermocouple

Diameter	Reference L type	Reference straight type	Length
Ø3 mm	TPL-03-100-T	TPL-D-03-100-T	100 mm
	TPL-03-200-T	TPL-D-03-200-T	200 mm
	TPL-03-300-T	TPL-D-03-300-T	300 mm
Ø6 mm	TPL-06-300-T	TPL-D-06-300-T	300mm
	TPL-06-500-T	TPL-D-06-500-T	500 mm
	TPL-06-800-T	TPL-D-06-800-T	800 mm
Ø8 mm	TPL-08-1000-T	TPL-D-08-1000-T	1000 mm
	TPL-08-1250-T	TPL-D-08-1250-T	1250 mm
Ø12 mm	TPL-12-1500-T	TPL-D-12-1500-T	1500 mm
	TPL-12-2000-T	TPL-D-12-2000-T	2000 mm
Ø14 mm	TPL-14-2500-T	-	2500 mm
	TPL-14-3000-T	-	3000 mm

## Options

- **Graduation** with red mark on the shaft, on request
- **TIG Welding** for a use up to 1000°C (except Pitot tube Ø3)

## Dimensions (in mm)

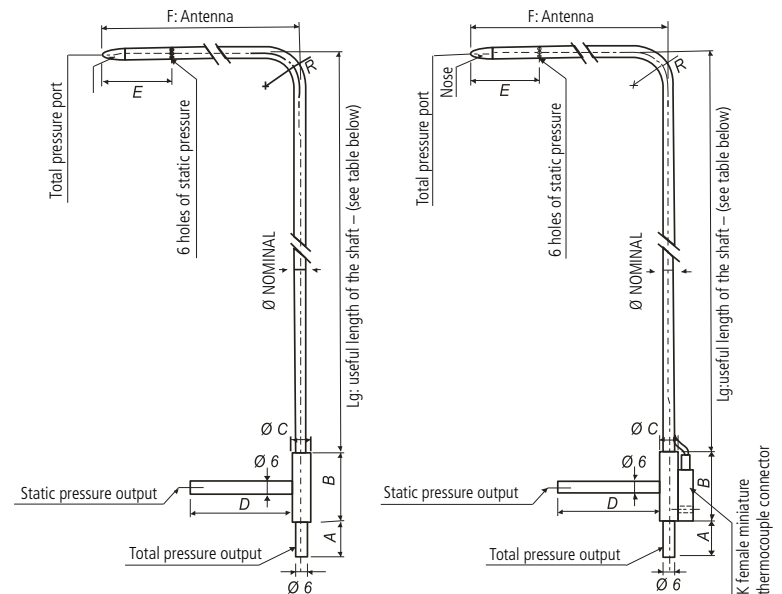

Pitot tube L type

Pitot tube L type with K thermocouple

	A	B	ØC	D	E	F	R
Pitot tube Ø3 mm	17	32	10	30	25	48	9
Pitot tube Ø6 mm	25	40	10	40	48	96	18
Pitot tube Ø8 mm	25	40	10	50	64	128	24
Pitot tube Ø12 mm	25	50	16	70	96	192	36
Pitot tube Ø14 mm	25	50	16	70	112	224	42



All dimensions and ratings of this document are specified in mm.

## Accessories

Name	Reference
Gland in plated brass for the installation of Pitot tubes for fixed station	x
Mounting flange stainless steel and cast iron	x
Sliding connections with stainless steel turn or PTFE	x
Extension cable for K thermocouple class 1	x
Stopper cap in caoutchouc: bag of 10 pieces	x
Caps: bag of 10 pieces	x
Black silicone tube (4 x 7 mm)	SN-47-1
Transparent silicone tube (4 x 7mm)	SB-47-1
Crystal tube (5 x 8 mm)	C-58-1
Plastic transport case type VTP for pitot tube and/or probe with a maximum size of 110 cm x 20 cm x 4 cm.	VTP / 23370
Junctions in Y for a tube Ø5 x 8 mm (bag of 10)	J.Y.C
Junctions in T for a tube Ø5 x 8 mm (bag of 10)	J.T.C



For every other cases, Sauermann offers special realisations. Consult us, we intervene on plans study, machining.

## Operating principle

The **Pitot tube** is introduced perpendicularly in the pipe by pre-determined points (cf. "Measurement").  
 The antenna composed of an ellipsoidal nose (bow) maintained in parallel and in front of the flow to control.  
 The total pressure (+) is picked up by the bow and is connected to the + sign of the manometer.  
 The static pressure (-) picked up by the small holes located around the antenna is connected to the - sign of the manometer.  
 The connecting cable of the K thermocouple is connected to the input K of the manometer (for the **Pitot tube type L with K thermocouple**).

The device then indicates the dynamic pressure, sometimes called speed pressure.

The dynamic pressure corresponds to the difference between total pressure and static pressure:  $Dp = Tp - Sp$

## Application

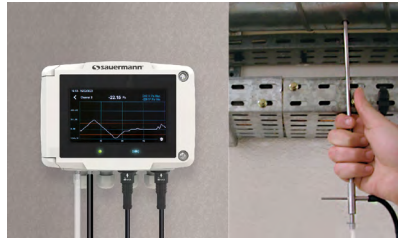
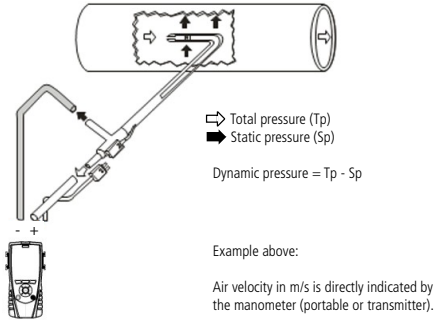

- GTC Record
- GTC Analyze

Low differential pressure transmitter sensor  
 CP210 and SQR/3



- Alarm
- Visualize
- Operate
- GTC Record
- GTC Analyze
- Live monitoring

Low differential pressure transmitter sensor with digital display  
 Si-C320 or CA 310 with  
 SPI 2 – 100, 500, 1000, 10000 and SQR/3



- Alarm
- Visualize
- Record
- Analyze
- Live monitoring

Multifunction intelligent portable  
 AMI 310

## Measurement

### • Punctual velocity measurement

From the dynamic pressure expressed in Pa, at an atmospheric pressure of 1013.25 mbar and a temperature of 20 °C, we determine the velocity in m/s, using the following simplified formula:

$$V = C_M \times 1.289 \times \sqrt{\Delta P} = 1.291 \times \sqrt{\Delta P}$$

Complete formula:

$$V = C_M \sqrt{\frac{2 \Delta P}{\rho}} \quad \rho = \frac{P_o}{287.1 \times (\Theta + 273.15)}$$

### • Air flow measurement

Average (A) of several measurements of punctual velocity according to Log-Tchebychev (see measurement scheme above).

#### Air flow calculation

Flow = Velocity<sub>A</sub> x Surface x 3600

Surface: surface of the circular or rectangular sheath in m<sup>2</sup>

N.B: in the electronic devices, the surface is automatically adjustable.

With:

Θ: temperature

P<sub>o</sub>: given atmospheric pressure (Pa)

C<sub>M</sub>: coefficient of the flow device element

Pitot tube L : C<sub>M</sub> = 1.0015

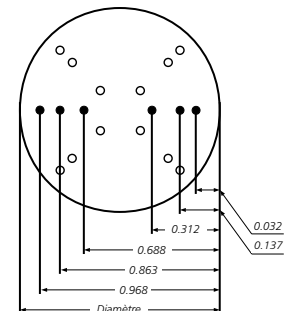
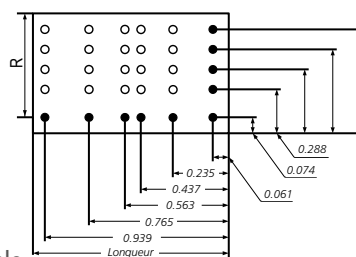

Log-Tchebychev in 3 points

With:  
 Flow: in m<sup>3</sup>/h  
 Surface: in m<sup>2</sup>  
 V<sub>A</sub>: in m/s



DISTRIBUTED BY:

**Sedulitas**

PEOPLE | PASSION | PRECISION

